



## Department of Energy

Office of Scientific and Technical Information  
Post Office Box 62  
Oak Ridge, Tennessee 37831

August 10, 2016

Re: OSTI-2016-01064-F

Dear Mr. Ravnitzky:

This is in final response to the request for information you sent to the Department of Energy (DOE), Office of Scientific and Technical Information (OSTI) under the Freedom of Information Act (FOIA), 5 U.S.C. 552 on June 22, 2016.

You requested a "copy of records, electronic, or otherwise, of each letter TO and FROM universities, companies, and organizations, from the OSTI 'cold fusion' documents collection." On July 11, 2016, you were emailed an interim response letter informing you of the need for OSTI to obtain release authorization from the Department of Energy. OSTI received notification to release the letters to you in their entirety on August 8, 2016. As a result, OSTI is releasing 72 cold fusion letters in this mailing on a CD-ROM because of the volume and file size of the PDFs.

In addition, there are approximately 13 letters that are currently being reviewed by the DOE's General Counsel Office (GC) for release or redaction. Upon receipt of guidance from GC, OSTI will release in whole or in part.

This decision, as well as the adequacy of the search, may be appealed within **90** calendar days from your receipt of this letter pursuant to 10 C.F.R. § 1004.8. Appeals should be addressed to Director, Office of Hearings and Appeals, HG-1, L'Enfant Plaza, U.S. Department of Energy, 1000 Independence Avenue, S.W., Washington, D.C. 20585-1615. The written appeal, including the envelope, must clearly indicate that a FOIA appeal is being made. You may also submit your appeal to [OHA.filings@hq.doe.gov](mailto:OHA.filings@hq.doe.gov), including the phrase "Freedom of Information Appeal" in the subject line. The appeal must contain all of the elements required by 10 C.F.R. § 1004.8, including a copy of the determination letter. Thereafter, judicial review will be available to you in the Federal District Court either: 1) in the district where you reside; 2) where you have your principal place of business; 3) where DOE's records are situated; or 4) in the District of Columbia.

You may contact OSTI's FOIA Public Liaison, Charlene Luther, Office of Preservation and Technology at 865.576.1138 or by mail at the Department of Energy, Office of Scientific and Technical Information, 1 Science.gov Way, Oak Ridge, TN 37830 for any further assistance and to discuss any aspect of your request. Additionally, you may contact the Office of Government Information Services (OGIS) at the National Archives and Records Administration to inquire about the FOIA mediation services they offer.

The contact information for OGIS is as follows: Office of Government Information Services, National Archives and Records Administration, 8601 Adelphi Road-OGIS, College Park, Maryland 20740-6001, e-mail at [ogis@nara.gov](mailto:ogis@nara.gov); telephone at 202-741-5770; toll free at 1-877-684-6448; or facsimile at 202-741-5769.

If you have any questions about the processing of the request or about this letter, please contact Madelyn M. Wilson at

Sincerely,

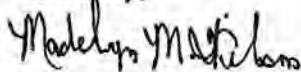

Madelyn M. Wilson  
FOIA Officer  
DOE OSTI  
1 Science.gov Way  
Oak Ridge, TN 37830

File - Sponsler

**GEORGE CURTIS SPONSLER**  
**ATTORNEY AT LAW**  
**7804 OLD CHESTER ROAD**  
**BETHESDA, MD 20817-6280**  
**(301) 320-3431**

September 9, 1996

Neal Blue  
Chairman  
General Atomics  
P.O. Box 85608  
San Diego, CA 92186

Dear Mr. Blue:

I am writing to inquire if General Atomics might propose to DOE and conduct a critical experiment to test a new theory of mine of what I call neutron-halo catalyzed triggered-fusion. Dr. Edward C. Creutz - retired director of your La Jolla Laboratory to whom I was referred by Dr. Frederick Seitz, president emeritus of both The Rockefeller University and the National Academy of Sciences - gave me your name.

Dr. Walter Polansky, director of DOE's Division of Advanced Energy Projects, has advised me that he could provide the \$200,000 to \$300,000 funding for the needed experiment, provided a reputable laboratory proposed the work and that proposal passed DOE peer review. If General Atomics, in return for a reasonable share of future license income (if any), would assist me in this regard, as well as perhaps aiding in the preparation of a Continuation in Part to my present patent application (although both a physicist as well as an attorney, I am not a patent attorney), I would welcome your assistance. Or perhaps you might prefer some other arrangement, which I would be pleased to consider.

Dr. Creutz also suggested Dr. Marshall Rosenbluth, a General Atomics consultant now with the University of California at San Diego, might assist you by reviewing my theory. If you would execute the enclosed Non-Disclosure Agreement ( my resume is also enclosed) I would be happy to provide you with a copy of my proprietary paper. I would welcome a review by such a distinguished scientist.

Sincerely,



George C. Sponsler

cc: E. C. Creutz (w/o enc)  
W. Polansky (w/o enc)  
F. Seitz (w/o enc)

enc.

## **DISCLAIMER**

**Portions of this document may be illegible in electronic image products. Images are produced from the best available original document.**

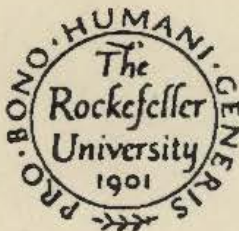
Sponsler**THE ROCKEFELLER UNIVERSITY**

1230 YORK AVENUE • NEW YORK, NEW YORK 10021-6399

August 13, 1996

Dr. George C. Sponsler  
7804 Old Chester Road  
Bethesda, Maryland 20817-6280

Dear George:

HOW WONDERFUL TO HEAR FROM YOU AND LEARN THAT YOUR MIND AND RELATED activities are running at the same full pace as ever!

I can understand your difficulties with Livermore unless you have a special ally there, since it is, in the last analysis, a weapons laboratory. Someone at the Fermi Lab might be more receptive, but I do confess that you probably would encounter a similar problem there although for different reasons.

One alternative which could be fruitful is to make contact with the Frascati Laboratory near Rome in Italy. It carried out a great deal of work on cold fusion which was never published since the results were negative, but, particularly if you can obtain funding, might well take your proposed experiment very seriously. My first-hand contacts there are with individuals in the solid state physics division. I can give you their names if you wish. They are sufficiently high that they could discuss the matter with the director.

An alternative suggestion is that you review the matter with Dr. Edward C. Creutz. He was a very successful nuclear physicist and then became research director at the General Atomics Laboratory in La Jolla. In fact, he and Freddy de Hoffmann created that laboratory in the 1950s and 1960s. Ed's address is as follows. Edward C. Creutz, P.O. Box 2757, Rancho Santa Fe, California 92067, Tel: (619) 756-1980. Ed has some form of minor palsy and does not write very well, nor does he have immediate access to secretarial services, so it might pay to call him, using my name when you do so.

Incidentally, I would like to see your manuscript at your convenience. I may see Creutz in Pittsburgh at the end of September at a fiftieth anniversary celebration of the creation of the Nuclear Physics Laboratory there by Ed Creutz.

Very best regards,

*Fred*  
Frederick Seitz

P.S. My fax is as follows: (212) 327-7559.

File  
(Sponsler)

**GEORGE CURTIS SPONSLER**  
**ATTORNEY AT LAW**  
**7804 OLD CHESTER ROAD**  
**BETHESDA, MD 20817-6280**  
**(301) 320-3431**

July 30, 1996

Dr. Frederick Seitz  
President Emeritus  
Rockefeller University  
1230 York Avenue,  
New York, N.Y. 10021

Dear Fred:

I would like to ask your advice in gaining the assistance of a reputable laboratory to test a theory of mine of catalyzed nuclear fusion - what I have termed "triggered-fusion" - on which I have been working (intermittently) over the past several years. I hold a pending patent application; so I would ask that you please treat the matter confidentially.

Dr. Walter M. Polansky, Director of DOE's Division of Advanced Energy Projects, has advised me that he could provide the \$200,000 to \$300,000 funding for the needed experiment, provided a reputable laboratory proposed the work and that proposal passed DOE peer review. I have contacted the Livermore Lab in this regard, but they are procrastinating because, I believe, they view the phenomenon as cold-fusion.

It is true that I began my work as an attempt to explain certain aspects of the now discredited cold-fusion, but it is not cold-fusion. My theory is that an incident (several hundred Kev) projectile deuteron (or proton) picks up a palladium-target atom skin-neutron as a halo, which in turn catalyzes a subsequent fusion event with a thermal deuteron absorbed in the palladium lattice. The theory is easily tested by conducting the needed experiment, measuring the fusion probability of the bombarding particle. My theory also shows that the hypothesized palladium atom's neutron-skin would explain the anomalous diffusion of hydrogen isotopes in palladium.

Should you wish, I would be happy to send you a copy of my theory. But I thought it might prove burdensome in light of your other commitments; so I decided simply to ask your advice, which I do solicit with my thanks for your help.

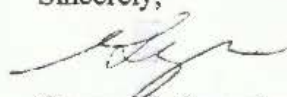
Sincerely,  
  
George C. Sponsler

cc: W. M. Polansky

File

**GEORGE CURTIS SPONSLER**  
**ATTORNEY AT LAW**  
**7804 OLD CHESTER ROAD**  
**BETHESDA, MD 20817-6280**  
**(301) 320-3431**

March 14, 1996

Dr. E. Bickford Hooper  
Assistant Deputy Associate Director  
Magnetic Fusion Energy Program  
Lawrence Livermore National Laboratory  
P.O. Box 808  
Livermore, CA 94551-9900

Dear Dr. Hooper:

After receiving your letter of October 4, 1995, following your suggestion, I consulted with my old friend and former Princeton classmate, Prof. Carroll Alley, who gave me entree' to the University of Maryland's physics library. I then purchased a new, more powerful, computer and have revised and rewritten my former paper, "Triggered-Fusion," copies of which I had previously forwarded you and Drs. Polansky and Tarter. I have enclosed the revised version, "Neutron-Halo Catalyzed Triggered-Fusion," without the Appendix thereto which also needs to be reworked.

As you will see, the revision is still subject to several of the legitimate criticisms to the earlier version which you raised in your letter of September 20, 1995. The principal question is the existence and life-times of the hypothesized excited states of the proton and deuteron triggers. The publication problem associated with my pending patent application also remains.

However, in your October 4 letter you said you would be pleased to look over my new calculations and, should they be promising, consider undertaking the needed experiment. On the assumption the proton and deuteron triggers are indeed activated and that their lifetimes are adequate for their subsequent fusions with thermal deuterons occluded in the palladium lattice, the fusion probabilities turn out to be about 8% and 11% respectively. I believe the associated theory is plausible and the results warrant proposing the needed experiment to DOE.

After reviewing the new paper, would you please again give me your advice and recommendations.

Sincerely,



George C. Sponsler

Enclosure

cc: W.M. Polansky  
C.B. Tarter

PROPRIETARY DATA  
For Evaluation Purposes Only

Neutron-Halo Catalyzed Triggered-Fusion

by

George C. Sponsler<sup>1\*</sup>

Abstract

Triggered-fusion is a new approach to the controlled nuclear fusion of certain ions with deuterons absorbed in a palladium crystal matrix. An incident beam of ions impacts a thin deuterium-saturated palladium target resulting in activation of the bombarding ions and their subsequent fusion with absorbed deuterons. The process is analyzed mathematically from the viewpoint of a single incident proton or deuteron trigger. A physical mechanism involving nuclear neutron-halos and neutron-skins is propounded to explain how palladium catalyzes the resulting triggered-fusion. Application is considered to the practical production of electric power.

I. Introduction

Triggered-fusion offers a new way to generate electrical power under controlled and reproducible circumstances by directing an energetic ion beam against a deuterium-saturated palladium target, thereby activating the bombarding ions and creating subsequent fusions with thermal deuterons absorbed in the palladium. This paper presents a proposed physical mechanism and associated mathematical theory to explain the process.

The physical mechanism envisions a two-step process: (1), an initial activation, in which an incident trigger ion acquires a halo-neutron of its own by capture of an hypothesized palladium skin-neutron; (2), followed by a subsequent fusion, mediated by the captured halo-neutron, of the activated trigger with a thermal deuteron absorbed in the palladium target. The captured neutron is, as with all ground-state halos, only loosely bound both as the trigger's halo-neutron as well as, previously, as a palladium skin-neutron.

A halo is a general phenomenon common to loosely bound particles in short-range potential wells. Such particles can tunnel quantum-mechanically into the space surrounding the nuclear potential well. Halos may thus increase the nuclear radius by factors of ten to twenty or more.<sup>1</sup> In the relevant energy ranges, halos involve a nuclear core with usually one or at most two valence neutrons and display the strength of a single-particle with

---

<sup>1\*</sup> President, Law Mathematics and Technology Incorporated,  
7804 Old Chester Road, Bethesda, Maryland, 20817-6280.



**PROPRIETARY DATA**  
For Evaluation Purposes Only

a low separation energy. Typical neutron halo<sup>2\*</sup> separation energies are of the order of 0.2 to 0.5 mev; and halo particle half-lives as great as 8.5 milliseconds (<sup>11</sup>Li) have been observed.

There is ample experimental evidence which substantiates the hypothesis that the nuclear potential may extend beyond the classical radius of the deuteron and of other atoms. As an early example, a shallow protruding shoulder potential - with a width double that of the then accepted rectangular deuteron potential well,  $2.8 \times 10^{-13}$  cm - was shown by Bohm and Richman<sup>2</sup> in 1946 to fit the experimentally measured scattering cross section of neutrons by free protons (see Bethe<sup>3</sup>).

It is also now well established that neutrons as halos may orbit the core of a nucleus, penetrating beyond the wall of the nuclear potential well.<sup>4</sup> As neutrons are carriers, as it were, of the nuclear force, such halos are analogous to penetration by the nuclear force beyond the classical nuclear radius.

Usually, halos (and hence their associated fields) are short lived ( $< 10^{-3}$  sec). But there are similar, stable nuclei which exhibit long lifetimes: so-called "pre-halos," exemplified by the deuteron itself; and "neutron-skin" nuclei such as palladium's periodic-table neighbor, silver<sup>5</sup>, wherein the bulk of the neutron density extends further from the nuclear center than does the proton density. Furthermore, halo neutrons may be both captured or lost by decay, and excited-state halos are also possible.<sup>6</sup>

As argued in the Appendix, it is very likely that the short-range attractive nuclear force associated with the presumed palladium neutron-skin locally counteracts the repulsive Coulomb force, thereby explaining both the unusually high diffusivity of hydrogen isotopes in palladium and, more particularly, the anomalous diffusivity of deuterium which experimentally is greater in palladium than that of hydrogen per se.

Tagigawa and Sagawa in 1991 suggested that the neutron halo might facilitate fusion reactions.<sup>7</sup> They showed that "the fusion cross section of a halo nucleus is drastically enhanced at low energies because of the lowering of the fusion barrier and the coupling of the translational motion to soft (dipole vibration) modes of excitation associated with the (valence) neutron halo." As elucidated in a subsequent paper<sup>8</sup>, they calculate an enhancement of up to four orders of magnitude of the fusion cross section at neutron-halo separation energies of 0.2 mev.

Experimental use of artificially-produced beams of hydrogen isotopes to induce nuclear reactions has been widely practiced since the original work of Cockcroft and Walton with protons in 1932<sup>9</sup>, for which they were awarded the 1951 Nobel Prize in Physics. Cockcroft and Walton also experimented with deuteron beams (e.g., in their 1934 transformation of the light lithium isotope into the heavy one)<sup>10</sup>.

Perhaps the first hydrogen fusion experiment was that of

---

<sup>2\*</sup> Experimentally, though less common than neutron halos, proton halos have also been observed.

T

**PROPRIETARY DATA**  
For Evaluation Purposes Only

Paneth and Peters, published in October 1926<sup>11</sup>, who attempted the conversion of hydrogen into helium using palladium as a catalyst. But their initial seeming success was subsequently reversed when they discovered the observed helium most probably had actually been an artifact in their experiment.

John Tandberg, working in Stockholm and influenced by the reports of Paneth and Peters, built an electrolytic cell using a palladium electrode in an attempt to separate hydrogen from oxygen in ordinary water.<sup>12</sup> Tandberg, in collaboration with Torsten Wilner, later repeated his electrolysis experiment using heavy water (D<sub>2</sub>O). In the 1940s Tandberg and Wilner bombarded a deuterium-saturated palladium metal sheet with deuterons - recording the generation of helium-three (<sup>3</sup>He) and neutrons. They may thus have been the first to have demonstrated triggered-fusion experimentally, if inadvertently and unrecognized as such.<sup>13</sup>

More recently, Brookhaven National Laboratory chemists claimed to have induced deuteron/deuteron (D/D) fusion by bombarding a deuterium impregnated target (composed of titanium or zirconium deuteride, or of polydeuteroethylene) with heavy water clusters containing from 25 to 1300 molecules, using beam energies of between 200 kev and 325 kev.<sup>14</sup> They theorized that the heat and compression generated by the impact caused pairs of deuterium atoms to fuse, momentarily creating <sup>4</sup>He and releasing the binding energy.

The Brookhaven experimental D/D fusion was enhanced over the anticipated theoretical rate by a factor of 10<sup>8</sup> (originally 10<sup>10</sup>, but reduced after an experimental artifact was identified). Brookhaven may thus have been the second group of scientists to have chanced unknowingly upon triggered-fusion, or a variant thereof, albeit not in a palladium matrix.

Palladium-catalyzed triggered-fusion might also explain some of the reported but questionable cold-fusion observations<sup>15</sup> if there were, for example, unrecognized (perhaps cosmic-ray induced) showers of energetic protons acting as triggers. Similarly, it might help explain the electrolysis experiments of James P. Herson with palladium-coated beads as reported on ABC television<sup>16</sup>.

The presently known hydrogen-isotope fusion reactions are listed in Table 1.<sup>17</sup> The reaction byproducts reported by Tandberg and Wilner correspond to the first so-called branch, with an energy release of 3.27 mev per reaction. (Note: 1.9x10<sup>12</sup> of these reactions would be needed every second to produce only one watt of power). A sixth reaction,  $T + p$ , is often added to Table 1, but this reaction may only be intermediary between the reactions on rows 2 and 3, above, as indicated by the sum of the released binding energies of  $D + D \rightarrow T + p$  (4.03 mev) and  $T + p \rightarrow ^4\text{He} + \text{gamma}$  (19.81 mev) compared with line 3 (23.85 mev) of Table 1.

PROPRIETARY DATA  
For Evaluation Purposes Only

**Table 1: Known Deuterium Fusion Reactions  
with Hydrogen Isotopes**

<u>PRIMARY REACTION</u>	<u>BRANCH PRODUCTS</u>	<u>ENERGY (E<sub>r</sub>) RELEASE (MeV)</u>	<u>REACTIONS/SEC PER 1W OUTPUT</u>
D + D →	<sup>3</sup> He + n	3.27	1.90x10 <sup>12</sup>
D + D →	T + p	4.03	1.54x10 <sup>12</sup>
D + D →	<sup>4</sup> He + gamma	23.85	2.61x10 <sup>11</sup>
T + D →	<sup>4</sup> He + n	17.59	3.53x10 <sup>11</sup>
p + D →	<sup>3</sup> He + gamma	5.49	1.13x10 <sup>12</sup>

The initiating trigger might be a proton, deuteron, or even helium-3, or perhaps yet other energetic ion capable of capturing a halo neutron from a palladium crystal atom; but consideration of neutron capture cross sections, as given by Table 2, indicates the proton might be most appropriate, were that the sole criterion for selection<sup>18</sup>. However, a deuteron trigger would be preferable because of the greater energy it would release (as a haloed-triton).

**Table 2:  
Neutron Cross Sections for Isotopes of Hydrogen & Palladium**

<u>ISOTOPE</u>	<u>Thermal σ</u>	<u>Integral σ</u>	<u>REMARKS</u>
<sup>1</sup> H	0.332 b	0.140 b	b = barns
<sup>2</sup> H	0.52 mb	0.23 mb	mb = milli b
<sup>3</sup> H	< 6 μb		μb = micro b
<sup>104</sup> Pd		16 b	11% of all Pd
<sup>105</sup> Pd	22 b	60 b	22% of all Pd
<sup>106</sup> Pd	0.1 b	0.3 b	27% of all Pd
<sup>108</sup> Pd	0.2 b	2 b	26% of all Pd

(Thermal Energy = 0.0253 ev; 0.5 ev < Integral Energy < 100 kev)

In passing, it might be noted that the comparatively low neutron cross sections for <sup>106</sup>Pd and <sup>108</sup>Pd, might be explained if those two isotopes possessed more pronounced neutron-skins which would make neutron capture less likely; whereas the high cross sections for <sup>104</sup>&<sup>105</sup>Pd might indicate the greater receptivity of isotopes not possessing such pronounced skins to acquire addition-

**PROPRIETARY DATA**  
For Evaluation Purposes Only

a1, halo-like skin neutrons.

## II. Theory

By "activation" is meant the process by which a trigger ion - initially taken to be a proton - captures a skin-neutron from a deuterium-saturated crystal matrix palladium atom. As is shown below, such capture increases the average radius of the trigger nucleus and thereby increases its probability of fusion with an absorbed deuteron, both by reason of its correspondingly increased "fairly-direct" collision cross section (required for fusion) and by the reduced net Coulomb barrier which is locally counteracted by the halo-neutron's short-range nuclear force.

The fusion cross section of two particles of radii  $r_1$  and  $r_2$  in the required fairly-direct collision is given by:

$$\sigma_f = \pi (r_1 + r_2)^2 \quad (1)$$

Empirically, the nuclear radius,  $r_o$ , of a nucleus composed of  $A$  nucleons is given by:<sup>19</sup>

$$r_o = 1.5 \times 10^{-13} A^{1/3} \text{ cm} \quad (2)$$

(This latter equation assumes, incidentally, that the nucleons are uniformly distributed over a sphere of radius  $r_o$ , and therefore it does not apply to haloed nuclei. For example, the normal [pre-halo] deuteron nuclear radius is actually about twice that given by eqn. 2).<sup>3\*</sup>

However, using (2) the ratio of the proton/palladium activation collision cross section,  $\sigma_{pPd}$ , to the cross section,  $\sigma_{pd}$ , for an inactivated fairly-direct collision of a proton trigger with a thermal deuteron approximately would be given by:

$$\frac{\sigma_{pPd}}{\sigma_{pd}} = \left[ \frac{1 + \sqrt[3]{A_{Pd}}}{1 + \sqrt[3]{A_d}} \right]^2 \quad (3)$$

where  $A_{Pd}$  is the palladium nucleus mass number (~106), and  $A_d$  is the mass number (2) of deuterium. For a proton trigger we see from (3) that the probability of a trigger activation collision is about six and one-half times greater than the probability of a fairly-direct p/D collision.

But a fairly-direct collision between an inactivated proton trigger and an absorbed thermal deuteron is far less likely to result in a fusion than were the trigger activated. Furthermore, a p/D fusion would be less likely than the activation-capture of a neutron by a proton trigger, because of the Coulomb barrier's inhibition of the fusion event. It follows, and I hereafter assume,

---

<sup>3\*</sup> The maximum Coulomb barrier potential of the deuteron experimentally is about 260 kev, corresponding to a nuclear radius of about  $4 \times 10^{-13}$  cm.

**PROPRIETARY DATA**  
For Evaluation Purposes Only

that the trigger most probably will have been activated prior to a (subsequent) fusion with an absorbed deuteron.

To make a better estimate of the halo radius, and to estimate the activation neutron-capture probability, I treat the activated proton trigger like a virtual deuteron the neutron of which is in a metastable state possessing a separation energy analogous to but lower than the binding energy of the stable deuteron.

If the potential,  $V(r)$ , were known, the binding (or, here, the separation) energy,  $E$ , is negative and is determined by the Schrödinger equation which, for the ground state and corresponding spherically symmetric wave function,  $\psi(r)$ , is given by:<sup>20</sup>

$$\frac{d^2u}{dr^2} + \frac{M}{\hbar^2} [E - V(r)] u = 0 \quad (4)$$

where  $r$  is the distance between neutron and proton,  $M$  is the mass of proton or neutron, and  $u(r) = r\psi$ .

Eqn. (4) cannot be solved directly for  $E$  since  $V(r)$  is unknown; but assuming a rectangular potential well of depth  $V_0$  and width  $a$  and letting  $E = -W$  (where  $W$ , the binding or separation energy, is positive), it can be shown that  $u = C \exp(-\alpha r)$  is a good approximation for  $u(r)$  and that  $1/\alpha$ , (a measure of the distance of the halo-neutron from the proton) is given by:<sup>21</sup>

$$r_0 = \frac{1}{\alpha} = \frac{\hbar}{\sqrt{MW}} \quad (5)$$

Other types of short-range potential function give about the same results as the rectangular well.<sup>22</sup>

Fig. 1 shows that, for an assumed range of separation energies between 0.2 and 0.5 mev, the halo contracts from about  $1.45 \times 10^{-12}$  to about  $9 \times 10^{-13}$  cm from the proton. For the Deuteron binding-energy of 2.19 mev, the separation,  $r$ , is  $4.4 \times 10^{-13}$  cm (in the center of mass system this corresponds to a radius of 2.2 cm). The effect of the halo neutron is thus to expand the effective radius of the (virtual) deuteron and, as will be shown, correspondingly increase the probability of fusion with a thermal deuteron absorbed in a palladium lattice or crystal matrix.

Lifetimes of the haloed proton (or metastable or virtual deuteron) are incapable of calculation by this approach, but the Heisenberg Uncertainty Principle relates the line-breadth of the separation energy to the lifetime by  $\Delta E \Delta t = \hbar$ .<sup>23</sup> The experimentally observed halo lifetimes, ranging from  $10^{-3}$  to  $10^{-12}$  sec, correspond to very sharp separation energy line-breadths ranging from  $6.6 \times 10^{-19}$  to  $6.6 \times 10^{-10}$  mev.

In subsequent applications, however, a more precise expression for the nuclear potential,  $V_n(r)$ , is needed than that of the rectangular well.

Heisenberg's Uncertainty Principle (in  $\Delta p \Delta x$  form) may be used to estimate the nuclear potential function in the vicinity of a halo or valence neutron. Following Bohm<sup>24</sup>, it takes a momentum  $p = \hbar/\Delta x$ , and hence an energy  $E = p^2/2m = \hbar^2/2m(\Delta x)^2$  to keep a deuteron

**PROPRIETARY DATA**  
For Evaluation Purposes Only

(or haloed proton) of mass  $m$  (proton and neutron spinning about their center of mass) localized within a region  $\Delta x$ . This momentum creates a pressure, as it were, which tends to resist localization of the deuteron. The pressure is opposed by the nuclear force of attraction which holds the deuteron together. The deuteron radius is determined by the equilibrium point where the nuclear force balances the effective pressure. That balance point is determined by the condition that the total energy,  $W$  (kinetic plus potential), must be a minimum.

If we neglect the binding energy and let  $W = \hbar^2/2m(\Delta x)^2 + V_n$ , where  $V_n$  is the nuclear potential, and set the partial derivative of  $W$  with respect to  $\Delta x$  equal to 0, we see  $V_n = -\hbar^2/2m(\Delta x)^2$ . For a halo neutron,  $\Delta x$  is equivalent to its radial separation,  $r$ , from the proton. Therefore the nuclear potential near the edge of the deuteron potential well may be approximated by the formula:

$$V_n(r) = -\frac{\hbar^2}{2mr^2} \quad (6)$$

This formula does not recognize that the halo neutron energy levels must be quantized (being given by the eigenvalues of the Schrödinger wave equation) but rather are assumed to be continuous. The approximation is correspondingly inexact and should be treated as giving only bounding or limit values.

The conclusion that the nuclear attractive force field in the vicinity of the edge of the potential well may be approximated by a  $1/r^2$  potential is supported by the work of Takigawa et al<sup>25</sup> who represent the positional density of a single neutron halo or valence neutron by the formula:

$$\rho(s) = \rho_o(\kappa) \frac{e^{-2\kappa r}}{r^2} \quad (7)$$

where  $r$  is the distance between the center of the valence neutrons and that of the core of the haloed particle, and the diffuseness parameter,  $\kappa$ , is related to the separation energy,  $s$ , and mass,  $M_N$ , of the valence neutron. For a haloed proton (or virtual deuteron)  $\kappa$  is given by:

$$\kappa = \sqrt{\frac{M_N s}{\hbar^2}} \quad (8)$$

and  $\rho_o(\kappa) = \kappa/2\pi$  for a single halo (or valence) neutron.

Because of the short range of the strong nuclear force, it is reasonable to assume that the effective potential created by a neutron halo should closely resemble the shape of the neutron density, given by eqn. (7). More particularly, it is reasonable that the nuclear potential should be attenuated by the same exponential factor,  $\exp(-2\kappa r)$ , in the vicinity of the potential wall. But  $\rho_o(\kappa)$  may not enter as a multiplicative constant, for to do so would reduce the potential to zero as a limit, rather than to

**PROPRIETARY DATA**  
For Evaluation Purposes Only

the required Heisenberg limit given by (6). As a better approximation of that potential, I therefore replace (6) by the following formula:

$$V_n(r) = -\frac{\hbar^2 e^{-2\kappa r}}{2mr^2} \quad (9)$$

As will be seen, (9) reduces to (6) when the separation (or binding energy)  $s = 0$ .

The net potential near the nuclear well of a haloed proton, would then be given by the sum of the repulsive Coulomb,  $V_c$ , and attractive nuclear,  $V_n$ , potentials:

$$V(r) = \frac{e^2}{r} - \frac{\hbar^2}{2mr^2} e^{-2\kappa r} \quad (10)$$

Equation 10 tacitly presents the net field of the haloed proton as seen by another proton without a halo. We, however, are interested in the field as experienced by a (thermal) deuteron absorbed in the palladium crystal lattice, the effect of which is to introduce yet another (pre-)halo neutron (with "separation energy" equal to the deuteron binding energy, 2.19 mev). The effect of this additional neutron (as all halo neutrons are presumed to act independently because of the short range of the nuclear force) is to add by superposition a third term to (10), identical to the second term thereof but with the separation energy,  $s$ , set equal to the deuteron binding energy:

$$V(r) = \frac{e^2}{r} - \frac{\hbar^2}{2mr^2} e^{-2\kappa(s)r} - \frac{\hbar^2}{2mr^2} e^{-2\kappa(s=2.19)r} \quad (11)$$

Equation 11 is plotted in figure 2. The top (or red) curve in fig. 2 represents the net potential of a normal deuteron ( $s=2.19$  mev) as seen by a normal proton. The second (middle, black) curve corresponds to the potential of the haloed-proton ( $s=0.25$  mev) also experienced by a normal (unhaloed) proton. The bottom (third or blue) curve represents the haloed-proton mutual potential as seen by a normal deuteron (possessing a single pre-halo neutron).

In passing it should be noted from the top curve of (11) that the peak net repulsive potential for the deuteron, about 260 kev, occurs at a radius of about  $4 \times 10^{-13}$  cm: both in agreement with the experimental values, and lending credence to the use of the potential function.

Figure 2 also demonstrates that the effect of the hypothesized (250 kev separation energy) neutron halo is, as anticipated, both to reduce the peak repulsive potential (to about 140 kev) and to increase the nuclear well radius (to about  $7 \times 10^{-13}$  cm). Both of these effects would increase the probability of fusion of a haloed (i.e. activated) proton trigger with a thermal energy deuteron absorbed in the palladium lattice, as calculated subsequently.

The probability,  $P_f$ , of fusion of a trigger particle (here a proton) with a thermal deuteron absorbed in a palladium crystal

**PROPRIETARY DATA**  
For Evaluation Purposes Only

matrix is given by:

$$P_f = P_{f|a} \cdot P_a \quad (12)$$

where:  $P_{f|a}$  is the joint probability that an activated trigger both collides fairly-directly with an absorbed thermal deuteron and penetrates its net potential barrier (i.e. the fusion probability of an activated trigger); and  $P_a$  is the probability the trigger was activated prior to its collision with the deuteron.

To determine  $P_a$  it is first necessary to determine the cross section,  $\sigma_{capture}$ , for a trigger capturing (via a stripping or pick-up type of nuclear reaction) a skin-neutron from a palladium ion. To do so I assume that capture is analogous to the capture of a free neutron by a proton, employing Bethe's formula<sup>26</sup>:

$$\sigma_{capture} = \pi \frac{e^2}{MC^2} \frac{\hbar}{MC} \sqrt{\frac{W_1}{E_0} \frac{(\sqrt{W_1} + \sqrt{W_0})^2 (W_1 + E_0)}{(W_0 + E_0) MC^2}} (\mu_p - \mu_n)^2 \quad (13)$$

where (with  $E$  being the kinetic energy of the trigger):  $W_1$  is the binding energy (here taken to be the skin-neutron separation energy,  $s$ ) of the stable (or, here, virtual) deuteron (for which  $W_1 = 2.19$  mev);  $E_0 = E - W_1$  ( $\sigma_{capture} = 0$ ,  $E < W_1$ );  $W_0$  (= 69 kev for the stable deuteron) is a fictitious binding energy for the deuteron singlet state determined from the low-energy, singlet-scattering cross section (and assumed to scale with  $W_1$ , so that  $W_0(s) = (.069/2.19)s$ ;  $\mu_p$  and  $\mu_n$  are the moments of proton and neutron in units of the nuclear magneton;  $M$  is the mass of neutron or proton;  $c$  is the velocity of light;  $e$  is the electron charge in esu; and  $\hbar$  is Planck's constant divided by  $2\pi$ .

To determine the activation probability, let  $Q$  be the probability that an incident trigger is not activated in traversing a path of total length  $x$ . Between  $x$  and  $(x+dx)$ ,  $Q$  is decreased by an amount equal to the probability that it is activated within that incremental distance. But this latter is equal to the probability that the trigger reaches the point  $x$  without activation, times the probability that if it is in this region activation does occur. This latter probability is simply  $\rho_{pd} \sigma_{capture} dx$ , so it follows that<sup>27</sup>  $dQ = -Q \rho_{pd} \sigma_{capture} dx$  where  $\rho_{pd}$  is the palladium concentration.

Since  $dQ/dx = (dQ/dE)(dE/dx)$ , when expressed as a function of  $E$ ,  $dQ = -\{[Q(E) \rho_{pd} \sigma_{capture}(E)]/[dE/dx]\} dE$  where the explicit dependence of both  $Q$  and the capture cross section on trigger energy,  $E(x)$ , have been introduced by their respective arguments. The derivative,  $dE/dx$ , will be evaluated subsequently; but assuming it is known as a function of  $E$ , to determine  $Q$  we integrate, as follows:



**PROPRIETARY DATA**  
For Evaluation Purposes Only

$$Q = \exp \left[ -\rho_{pd} \int_{E_t}^E \frac{\sigma_{capture}(E)}{\frac{dE}{dx}} dE \right] \quad (14)$$

When expressed as a function of  $x$ ,  $\sigma_{capture}(x)dx$  is a probability and therefore has maximum value 1 and minimum 0, as do all probabilities. Expressed as a function of  $E$ ,  $\sigma_{capture}(E)$  when multiplied by  $dE/(dE/dx)$  must still be a probability with the same bounds. As  $\sigma(E)$  has a mathematical pole at  $E = 0$ , it follows that  $\sigma(E)$  is a Dirac delta function. Because it is a delta function its integral,  $\int \{[\sigma(E)\rho_{pd}]/[dE/dx]\}dE$ , equals the value of its integrand at the pole where  $E = s_{pd}$ , namely:

$$Q = \exp \left( \frac{-\rho_{pd}}{\left| \frac{dE}{dx} \right|_{E=s_{pd}}} \right) \quad (15)$$

As is apparent,  $Q$  is explicitly a function of  $\rho_{pd}$ ; implicitly, it is also a function of  $E$ , as will be apparent from the subsequent derivation of  $dE/dx$ . But first, in passing, it should be noted that  $Q(\rho_{pd} = 0) = 1$ , and  $Q(\rho_{pd} = \infty) = 0$ , as it should.

The desired probability,  $P_a(E)$ , that the trigger particle has been activated by the point at which its energy has attenuated to  $E$  is given by  $P_a = (1 - Q)$ :

$$P_a = 1 - \exp \left( \frac{-\rho_{pd}}{\left| \frac{dE}{dx} \right|_{E=s_{pd}}} \right) \quad (16)$$

As will be shown subsequently  $dE/dx$  is about 8 mev/cm for the normal palladium concentration of  $1.563 \times 10^{22}$  atoms per cc, and therefore the probability of activation, given by (15), is essentially unity. Thus, if the probability of capture is indeed satisfactorily represented by the Bethe formula of equation (13), the proton trigger will always be activated, provided the thickness of the palladium target is sufficiently great ( $\sim 0.6$ mm for  $E_t=500$ -kev) to assure that the trigger energy is attenuated to the separation energy of the activated proton.

Whereas, as we shall see,  $E$  attenuates gradually and continuously from the initial trigger kinetic energy,  $E_t$ , that energy must change discontinuously to  $(E - s_{pd} \sim 0)$  at the time of neutron capture, thereby supplying the energy needed to separate the valence skin-neutron from its palladium nucleus. It is further assumed that, after this separation from the palladium skin, the neutron is then bound to the capturing trigger particle, thus liberating  $s_p$  (the proton-halo separation energy) which it is assumed is transformed into kinetic energy of the now haloed trigger, rather than being emitted as a gamma ray of equivalent

**PROPRIETARY DATA**  
For Evaluation Purposes Only

energy. This is to say that, at the time of capture,  $E$  is assumed to change discontinuously from  $s_{pd}$  to  $s_p$ , the latter separation energy being assumed to be less than the former.

As should be apparent, the initial trigger energy,  $E_t$ , is also assumed to be less than the stable deuterium binding energy (2.19 mev), but greater than the palladium skin separation energy,  $s_{pd}$ , in order that the Pd skin-neutron be captured as a halo rather than as a stable deuterium's neutron.

To derive  $dE/dx$ , consider a single cubic cell of a pure, face-centered palladium crystal saturated with deuterium. The crystal lattice constant or cell-width,  $a$ , is almost exactly  $4 \times 10^{-8}$  cm. There is one palladium atom at each corner, and there are assumed to be  $f$  "free" electrons and  $(46 - f)$  "bound" electrons, these latter uniformly distributed within a sphere of radius  $r$  centered on each palladium nucleus. The probability,  $P_{pd}$ , that a particle incident on a cell penetrates one of the bound electrons' eight segments within the cell (and hence of any and all cells) is given by  $(4/3)\pi(r/a)^3$ ; while the probability,  $P_f$ , that the particle passes through the intervening free electrons is given by  $(1 - P_{pd})$ .

Imagine the path of the incident particle to be a series of random, broken line-segments (rather like a Brownian-motion random-walk with bias, or the ricochets in a pin-ball machine) between collisions with the palladium crystal atoms, with a total path length  $x$ .<sup>4\*</sup> The incident trigger particle will lose energy through successive collisions with both the bound and free electrons, the differential loss,  $dE/dx$ , being given by:

$$\frac{dE}{dx} = P_{pd} \left. \frac{dE}{dx} \right|_b + P_f \left. \frac{dE}{dx} \right|_f \quad (17)$$

where the subscripts  $b$  and  $f$  refer to bound and free respectively.

Jackson<sup>28</sup> derives the various differential energy loss formulae needed to evaluate (17). Quantum mechanics is only required in the derivation of the Bethe formula<sup>29</sup> for the energy loss at high (1 mev and greater) incident particle energy,  $E$ :

$$\left. \frac{dE}{dx} \right|_b = \frac{92\pi\rho_{pd}Z^2e^4M_z}{mE} \ln \left[ \frac{4mE[\gamma(E)]^2}{M_z\hbar(\omega_b)} - \frac{2E}{M_zc^2} \right], \quad E \geq 1 \text{ mev} \quad (18)$$

where  $\rho_{pd}$  is the concentration of palladium crystal atoms per cc;  $Z$  &  $M_z$  are the atomic number and mass of the incident particle;  $e$  &  $m$  are the electron charge and mass;  $\gamma(E) = [1 + (E/M_zc^2)]$  is a relativistic correction term; and  $\omega_b$  is an average palladium-atom bound electron frequency (taken to be 552 ev or  $8.83 \times 10^{-10}$  ergs,

---

<sup>4\*</sup> Discontinuous, decremental energy losses due to inelastic, "activation" collisions (see above discussion) are to be expected, but do not alter  $dE/dx$  prior to activation. Metals such as titanium, possessing low hydrogen-ion diffusivities, are excluded from consideration.

**PROPRIETARY DATA**  
For Evaluation Purposes Only

per Jackson's example<sup>30</sup>).

A classical, differential energy-loss formula is employed (with correspondingly different electron concentrations) for both bound and free electron collision losses at incident particle energies,  $E$ , less than 1 mev, and also (for computational convenience) as an approximation for (the smaller) free-electron collision losses at higher energies. (This latter use is permitted not only because incident-particle energy attenuation is much greater by bound electrons than free electrons, but the cumulative probability of collision and fusion of an incident high-energy trigger with an occluded thermal deuteron typically is less than 2% at energies greater than the peak deuteron barrier potential inside the palladium matrix).

The classical formula is derived from an expression yielding the energy transferred to a free electron during a Coulomb collision, as a function of the so-called impact parameter (or closest approach),  $b$ , given by<sup>31</sup>:

$$\Delta E(b) = \frac{Z^2 e^4 M_Z}{mE} \cdot \frac{1}{\left[ b^2 + \left( \frac{M_Z Z e^2}{2mE} \right)^2 \right]} \quad (19)$$

where  $Z$  refers to the atomic number of the incident trigger.

The desired formula for the free-electron differential energy loss is obtained by integrating (19) from 0 to  $b_{max}$ , as follows<sup>32</sup>:

$$\left. \frac{dE}{dx} \right|_f = 2\pi\rho_e \int_0^{b_{max}} \Delta E(b) b db \quad (20)$$

where  $\rho_e$  is the electron concentration (with  $e = b$  or  $f$ , for bound or free electrons, respectively); and  $b_{max}$  is given by<sup>33</sup>:

$$b_{max}(E) = \frac{\gamma(E)}{\omega} \sqrt{\frac{2E}{M_Z}} \quad (21)$$

where  $\omega$  is a characteristic atomic frequency of motion, in numerical calculations chosen so as to match the Bethe and free electron formulae (with  $e = b$ ) at  $E = 1$  mev (which yields a value of about 1.4 kev for  $\hbar\omega$ ).

Equation (20) is integrable in closed form, yielding:

$$\left. \frac{dE}{dx} \right|_e = \frac{\pi\rho_e e^4 M_Z Z^2}{mE} \ln \left[ 1 + \left( \frac{2b_{max}(E) mE}{Z M_Z e^2} \right)^2 \right] \quad (22)$$

where the subscript  $e$  is either  $f$  (for free) or  $b$  (for bound), as before, and  $\rho_f = f\rho_{pd}$  or  $\rho_b = (46-f)\rho_{pd}$  (with  $f$  being the number of free electrons). This formula is used in the subsequent calculations for bound electrons when  $E \leq 1$  mev, and for free electrons

**PROPRIETARY DATA**  
For Evaluation Purposes Only

for all  $E$ .

To appreciate how rapidly the incident-particle energy attenuates along the path length of the incident particle within the deuterium-saturated palladium crystal, it is only necessary to integrate eqn. (17):

$$x(E) = \int_E^{E_t} \frac{1}{\left[ P_{Pd} \frac{dE}{dx} \Big|_b + P_f \frac{dE}{dx} \Big|_f \right]} dE \quad (23)$$

Here  $x(E)$  is the total distance along the jagged path followed by an incident particle of initial (or trigger) energy,  $E_t$ , to the point where the particle energy has attenuated to  $E$ . The differential energy losses,  $dE/dx|_b$  and  $dE/dx|_f$ , are given by (18) and (20) above for the various energy ranges noted before.

We see from fig. 3 that an initial 500 kev proton trigger's kinetic energy attenuates to 250 kev after about 0.6 mm. Furthermore, if we insert (23) in (17) and evaluate the latter for  $E = 250$  kev, we find that  $dE/dx$  is about 8 mev per cm, as stated above in the discussion of the activation probability,  $P_a$ , there shown to be unity.

The differential fusion probability,  $dP_f$ , of an incident trigger with a thermal deuteron occluded within a palladium lattice target is then given by:

$$dP_f = \frac{\rho_D \sigma_f Q(E) T(E)}{\left[ P_{Pd} \frac{dE}{dx} \Big|_b + P_f \frac{dE}{dx} \Big|_f \right]} dE \quad (24)$$

where the fairly-direct collision cross section,  $\sigma_f$ , is given by (1);  $\rho_D$  is the concentration of deuterium within the palladium lattice; and  $Q$  is the probability that an incident trigger has not experienced a fairly direct collision with an occluded deuteron by the point at which its kinetic energy had attenuated to ( $E$ ); and  $T(E)$  is the transmissivity or probability that the incident trigger penetrates (i.e. tunnels through or passes over) the deuteron's net Coulomb barrier (the net mutual barrier, reflecting the reduction effected by the activated trigger's halo neutron).

The WKB approximation for the transmission probability,  $T(E)$ , of a trigger of mass  $M_t$  penetrating a thermal deuteron by quantum mechanically tunneling through a barrier potential,  $V(r)$ , is given by<sup>34</sup>:

$$T(E) = \exp \left[ -\frac{2}{\hbar} \int_{r_0}^{r_1} \sqrt{2M_t (V(r) - E)} dr \right] \quad (25)$$

where  $r_0$  is the lower radius and  $r_1$  the upper radius at which the

**PROPRIETARY DATA**  
For Evaluation Purposes Only

mutual barrier potential,  $V(r)$ , equals the relative energy,  $E$ , of the trigger; and  $V_r$  is given by (11). Of course,  $T(E) = 1$  for  $E$  greater than the maximum barrier potential.

Figure 4 presents  $T(E)$  for a haloed-proton penetrating the mutual potential barrier with a thermal deuteron absorbed in a palladium lattice, this latter as represented by the bottom or third curve of figure 2.

As  $Q$  is the probability that an incident trigger does NOT make a fairly-direct collision in the path length  $x$ , between  $x$  and  $(x+dx)$   $Q$  is decreased by an amount equal to the probability that such a collision does occur within that incremental distance. But this amount is equal to the probability that the particle reaches the point  $x$  without such a collision, times the probability that if it is in this region such a collision does occur. This latter probability is simply  $\rho_D \sigma_f dx$ , so that<sup>35</sup>  $dQ = -Q \rho_D \sigma_f dx$  where  $\rho_D$  is the deuterium concentration. Since  $dQ/dx = (dQ/dE)(dE/dx)$ , when expressed as a function of  $E$ ,  $dQ = -[Q \rho_D \sigma(E)]/[dE/dx] dE$ . Integration then yields:

$$Q(E) = \exp \left[ -\rho_D \sigma_f \int_{E_t}^E \frac{1}{\left[ P_{Pd} \frac{dE}{dx} \Big|_b + P_f \frac{dE}{dx} \Big|_f \right]} dE \right] \quad (26)$$

where (17) above has been substituted for  $dE/dx$ ,  $E_t$  is the initial trigger energy, and  $\sigma_f$  is again given by (1).

The cumulative probability of fusion,  $P_f$ , is given by integrating (24), as follows:

$$P_f = \rho_D \sigma_f (ht) \int_0^{V_{max}} \frac{T(E) Q(E)}{\left[ P_{Pd} \frac{dE}{dx} \Big|_b + P_f \frac{dE}{dx} \Big|_f \right]} dE + \rho_D \sigma_f (ht) \int_{V_{max}}^{s_{ht}} \{T=1\} dE + \rho_D \sigma_f (t) \int_{s_{pd}}^{E_t} \{T=1\} dE \quad (27)$$

where  $\{T=1\}$  in the second and third integral is the same integrand as in the first, but with  $T(E)=1$  and with the  $dE/dx$  denominator evaluated to reflect the mass of the haloed-trigger and normal (unhaloed) trigger in the second and third integral, respectively (the two differing by the mass of the halo-neutron).

In (27)  $\sigma_f(ht)$  and  $\sigma_f(t)$  are the fairly-direct collision cross sections for fusions of a haloed and normal (unhaloed) trigger, respectively, with a thermal deuteron occluded in a palladium lattice.  $V_{max}$  is the maximum value of the mutual potential of the haloed-trigger and thermal deuteron (fig. 2, bottom curve); and  $s_t$  and  $s_{pd}$  are the separation energies of the halo-neutron and skin-neutron of the activated trigger and palladium, respectively.

Assuming these latter two separation energies are 250 and 500 kev, respectively, and arbitrarily for illustration taking the initial trigger energy,  $E_t$ , to be 5 mev, for a proton trigger

**PROPRIETARY DATA**  
For Evaluation Purposes Only

$P_f = 0.08$  or 8%.

Of course, a practical power generator would use the lowest practicable trigger energy, but that must at least equal the palladium skin-neutron separation energy in order that it may strip that neutron and become activated, as discussed earlier.

The contribution to the total fusion probability made by the unhaloed trigger before activation is small (about 0.002, in the illustration), as also is the first integral in (27) which corresponds to the tunneling of the potential barrier. The major contribution to the cumulative probability of fusion comes from the second term (integral) which reflects the total probability of fusion of the activated trigger with a thermal deuteron at kinetic energies below the separation energy of the latter but above the maximum net mutual repulsion potential.

If we assume a deuteron trigger is, like the proton, also certain of activation, then its cumulative fusion probability is greater. To calculate  $P_f$  for a deuteron trigger the  $dE/dx$  expression of (17) must be evaluated for the larger mass, and the mutual potential must be revised to include the effect of the additional neutron. Corresponding to the second and third potentials of fig. 2, equations 10 and 11 must now be replaced by:

$$V(r) = \frac{e^2}{r} - \frac{\hbar^2}{2mr^2} e^{-2\kappa(s)r} - \frac{N\hbar^2}{2mr^2} e^{-2\kappa(s=2.19)r} \quad (28)$$

where  $N=1$  or  $2$  for the mutual potential as seen by a proton or deuteron, respectively (reflecting the additional neutron of the latter).

These potentials are graphed in figure 5, together with the pre-halo deuteron potential to facilitate comparison with fig. 2: the lower two curves in fig. 5 represent the mutual potentials as seen by a proton (middle, or second curve) and deuteron (bottom, or third).

Calculation yields the cumulative fusion probability of an activated with a thermal deuteron to be  $P_f = 0.117$ , for the same assumed parameters as incorporated above for the proton trigger.

### III. Conclusion

The proton and deuteron triggers differ in the amount of energy expected to be produced.

From table 1, it is seen that an activated proton trigger (corresponding to a deuteron), in a resulting fusion with a thermal deuteron absorbed in the palladium lattice, would produce 3 or 4 mev depending upon which nuclear branch resulted. Whereas an activated deuteron (corresponding to a triton) fusing with a thermal deuteron would produce almost 18 mev of energy.

To determine the expected energy production, it is necessary to multiply the fusion energy produced by the corresponding probability of fusion,  $P_f$ . The total energy to be expected is then obtained by adding the energy of the trigger, which is recovered in the form of heat from the palladium target.

**PROPRIETARY DATA**  
For Evaluation Purposes Only

For a proton trigger, this overall expected energy production is about 780 keV; for a deuteron trigger the figure is 2.56 MeV (both for an assumed 500 keV trigger energy). Thus a practical power generator with a proton trigger would need an overall thermal efficiency greater than 65% to produce net power output *vis a vis* power input. Most heat engines could not operate at this efficiency.

But with a deuteron trigger (assuming an activation probability of 100%), the needed overall thermal efficiency is only 20% to break even. This is a more reasonable figure, and offers the production of practical power for correspondingly greater thermal efficiencies.

However all of these calculations are based on far-reaching, if logically reasonable, assumptions. Only actual experiment will determine whether or not those assumptions, and the resulting conclusions, are valid. The simplest such experiment would be to bombard a deuterium-saturated palladium target with proton and deuteron beams of different kinetic energies, and to measure the resulting fusion probabilities. A potential new source of fusion power is tantalizing, and strongly supports such an experiment.

#### IV. References

1. B. Jonson, "Halo Nuclei," *Nuclear Physics A*, " 574, (1994), see also P. G. Hansen, "Exotic edge of nuclear darkness," *New Scientist*, 9 October, (1993).
2. Bailey, et al., *Phys. Rev.* 70, 583, (1946); and D.H. Frisch, *Phys. Rev.* 70, 589, (1946).
3. H.A. Bethe, *Elementary Nuclear Theory*, 44, Wiley, New York, figure 8 of Chapter IX, (1947).
4. K. Riisager, "Nuclear halo states," *Reviews of Modern Physics*, " Vol. 66, No. 3, July, (1994).
5. E. H. S. Burhop et al., "... the existence of a neutron halo in heavy nuclei," *Nuclear Physics A*, 132, (1969).
6. K. Riisager, *op cit*.
7. N. Takigawa & H. Sagawa, "Interaction potential and fusion of a halo nucleus," *Physics Letters B*, " 265, (1991).
8. N. Takigawa et al., "Fusion of a halo nucleus ...," *Nuclear Physics A*, " 538, (1992).
9. J. D. Cockcroft and E. T. S. Walton, *Roy. Soc. Proc.*, vol 137, p. 229, (1932).
10. M. Born, *Atomic Physics*, 4th Ed., Hafner, N.Y., p. 68, (1946).

**PROPRIETARY DATA**  
For Evaluation Purposes Only

11. F. Paneth & K. Peters, "Über die Verwandlung von Wasserstoff in Helium," *Berichte d. Deutschen Chemischen Gesellschaft*, **B59**, 1926, (also **B60**, 1927) translated by P. Allison & K. Lockner, Los Alamos Nat. Lab., (1989).
12. A. Fisher, "Much Ado About ...," *Mosaic*, (a publication of the National Science Foundation), **21**, No. 2, pp. 12 - 23, (1990).
13. Id.
14. R. Beuhler, G. Friedlander, & L. Friedman, *Physical Review Letters*, **63**, 1292, Sept. 18, 1989; also reported as: "Brookhaven Chemists Find New Fusion Method," *Science*, **245**, p. 1448, (1989).
15. M. Fleischmann, S. Pons, & M. Hawkins, "Electrochemically Induced Nuclear Fusion of Deuterium," *J. Electroanal. Chem.*, **261**, p. 301, 1989, and erratum, **263**, p. 187, (1989).
16. J. P. Herson, as reported 2/7/1996.
17. Taken from: *Cold Fusion Research*, A report of the Energy Research Advisory Board to the U.S. Dept. of Energy, p.5, Nov. (1989).
18. N. E. Holden, ed., *CRC Handbook of Chemistry & Physics*, '95 - '96 edition, CRC Press, N.Y. (1993).
19. H.A. Bethe, *Elementary Nuclear Theory*, 44, Wiley, New York, eqn. (3), (1947).
20. Bethe, *op. cit.*, eqn. (26), p. 31.
21. Id., pp 31 - 33, eqn. (29b).
22. Id., p 33.
23. Bohm, *op. cit.*, p 226.
24. Bohm, *op. cit.*, p. 102.
25. N. Takigawa et al, *op. cit.*, (1991) & (1992).
26. Bethe, *op. cit.*, p 61, eqn. (114).
27. D. Bohm, *Quantum Theory*, Prentice-Hall, N.Y., p. 513, (1951).
28. J.D. Jackson, *Classical Electrodynamics*, 2nd Ed., Chapter 13, Wiley, N.Y. (1975)
29. Id. at p. 629, eqn. (13.44).



**PROPRIETARY DATA**  
For Evaluation Purposes Only

30. Id., p. 652, problem 13.2.
31. Id., p.652, prob. 13.1.
32. Id., p. 621, eqn. (13.11).
33. Id., p. 621, eqn. (13.9).
34. Bohm, op. cit., p. 279
35. D. Bohm, *Quantum Theory*, Prentice-Hall, N.Y., p. 513, (1951).

New Energy Times

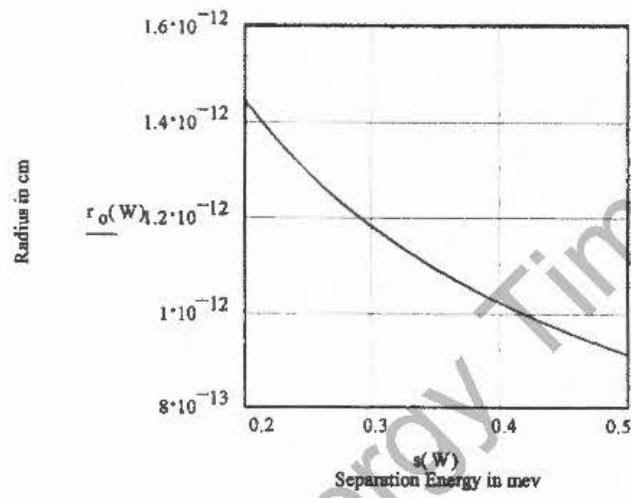

fig 1: Halo Radius vs Separation Energy

New Energy Times

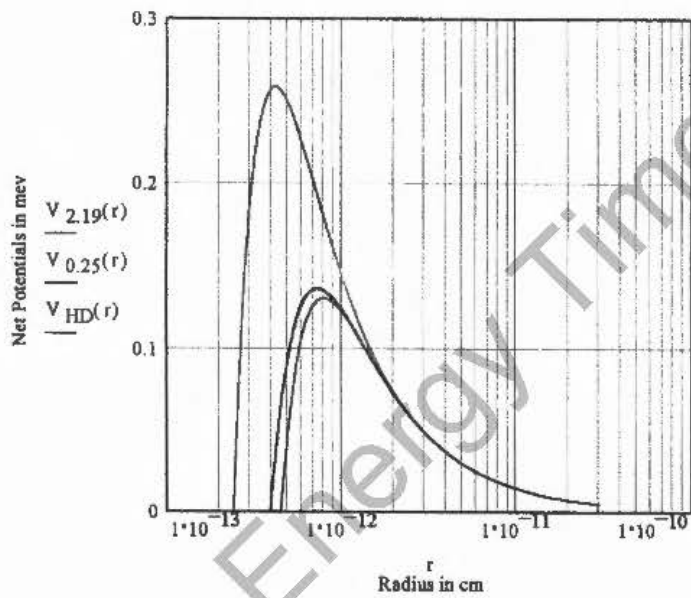

fig 2: Net Halo Potentials (D, H, & HD)

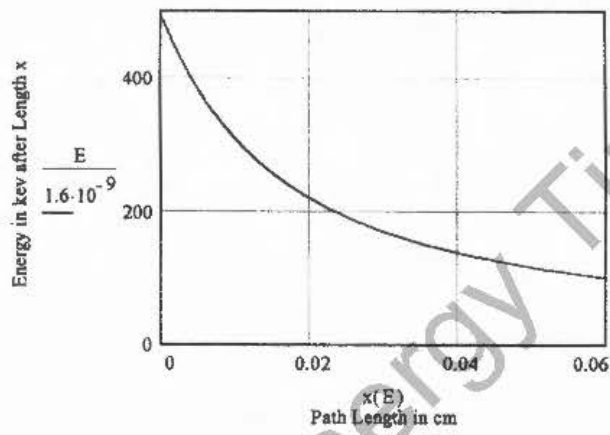

fig 3: Trigger Energy Attenuation

New Energy Times

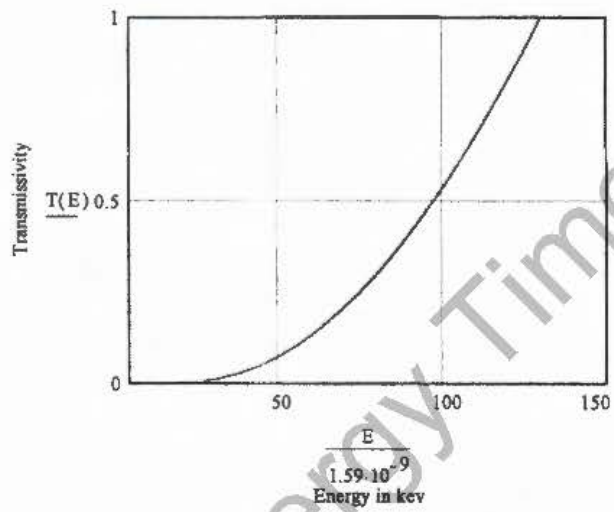

fig 4: Transmissivity vs Trigger Energy

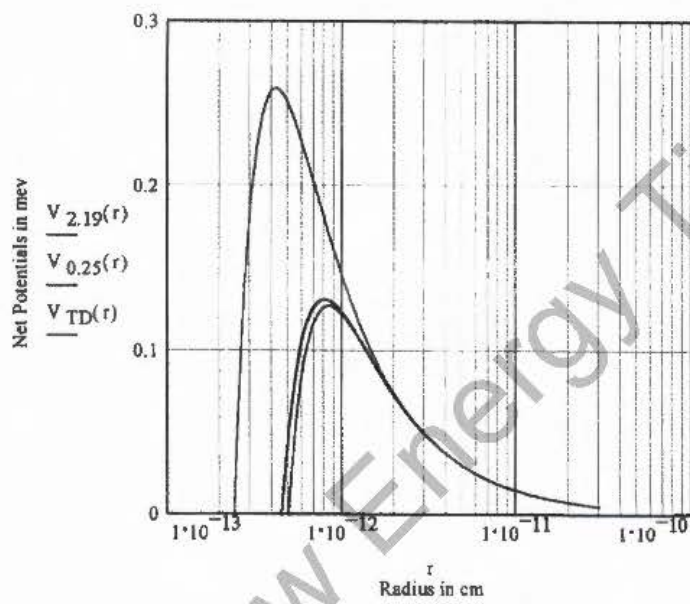

fig 5: Net Halo Potentials (D, T, & TD)

File - Sponsler

GEORGE CURTIS SPONSLER  
ATTORNEY AT LAW  
7804 OLD CHESTER ROAD  
BETHESDA, MD 20817-6280  
(301) 320-3431

April 17, 1996

Dr. E. Bickford Hooper  
Assistant Deputy Associate Director  
Magnetic Fusion Energy Program  
Lawrence Livermore National Laboratory  
P.O. Box 808  
Livermore, CA 94551-9900

Dear Dr. Hooper:

Further to my previous letter of March 14, I am enclosing herewith the Appendix: Diffusion of Hydrogen Isotopes in Palladium. Would you please replace pages 16 *et seq* of the prior paper, Neutron-Halo Catalyzed Triggered-Fusion, with this present enclosure.

I invite your attention to the new figure 6 which superimposes a Fermi-Thomas approximation, with a screening-radius of  $10^{-11}$  cm, over the net-potential curves of the prior figure 2. The good fit validates my use of the Fermi-Thomas equation for that purpose in my earlier papers.

Sincerely,



George C. Sponsler

Enclosure

cc: W.M. Polansky  
C.B. Tarter

**PROPRIETARY DATA**  
For Evaluation Purposes Only

For a proton trigger, this overall expected energy production is about 780 kev; for a deuteron trigger the figure is 2.56 mev (both for an assumed 500 kev trigger energy). Thus a practical power generator with a proton trigger would need an overall thermal efficiency greater than 65% to produce net power output *vis a vis* power input. Most heat engines could not operate at this efficiency.

But with a deuteron trigger (assuming an activation probability of 100%), the needed overall thermal efficiency is only 20% to break even. This is a more reasonable figure, and offers the production of practical power for correspondingly greater thermal efficiencies.

However all of these calculations are based on far-reaching, if logically reasonable, assumptions. Only actual experiment will determine whether or not those assumptions, and the resulting conclusions, are valid. The simplest such experiment would be to bombard a deuterium-saturated palladium target with proton and deuteron beams of different kinetic energies, and to measure the resulting fusion probabilities. A potential new source of fusion power is tantalizing, and strongly supports such an experiment.

**Acknowledgements**

This work has benefitted from discussions with George Chambers and Graham Hubler, both of the Naval Research Laboratory, and with Edmond Storms of the Los Alamos National Laboratory. I want to thank Gerald M. Hale, also of Los Alamos, for calling my attention to Jackson's textbook, and for providing certain data on branching probabilities. I also want to thank: Alexander Glass, Bickford Hooper, and John Perkins of Lawrence Livermore National Laboratory and Walter Polansky of the Department of Energy for their advice and counsel; Professor Carroll Alley of the University of Maryland for his kind library assistance; and Heinz Gorges, Vineta president, for his economic analysis of an early embodiment of my invention.

APPENDIX

**DIFFUSION OF HYDROGEN ISOTOPES IN PALLADIUM**

Hydrogen diffuses more rapidly in metals than any other solute. The rate of diffusion depends strongly upon the host metal; properties such as lattice type, electronic structure, and elastic moduli play key roles.<sup>36</sup> Hydrogen diffusivity is particularly marked in palladium, vanadium, niobium, and tantalum. It is also observed in iron, nickel, and other metals. The diffusion coefficient depends upon hydrogen concentration. Hydrogen diffusivities differ widely: that in palladium is  $10^6$  times greater than in titanium.<sup>37</sup> At temperatures above 250°C the diffusion coefficient,  $D$ , is higher for iron than it is for palladium; but the solubility of hydrogen in both Fe and Ni is low.<sup>38</sup>

The palladium-hydrogen system was first studied more than a



**PROPRIETARY DATA**  
For Evaluation Purposes Only

century and a quarter ago, and has been the most intensively studied ever since. Yet the physical mechanism for this rapid diffusion is not really understood. Alefeld & Völkl conclude that "the theoretical interpretation of the diffusion of H in metals is still quite unsatisfactory."<sup>39</sup>

Palladium exhibits several hydrogen-isotope anomalies which are particularly intriguing and, to date, inexplicable. The most widely recognized of these anomalies is the disparity of deuterium/protium diffusivities.<sup>40</sup> According to classical rate theory, the ratio of diffusivities,  $D_d/D_p$ , should be inversely proportional to the square root of their mass ratio, i.e.:

$$\frac{D_d}{D_h} = \left( \frac{m_d}{m_h} \right)^{-\frac{1}{2}} \quad (1A)$$

But, contrary to this formula, experimentally<sup>41</sup> deuterium diffuses faster than protium in palladium at temperatures below about 500°C.<sup>5\*</sup> Tritium requires more measurements, but also appears to be anomalous at lower temperatures.

Four different physical mechanisms have been employed to explain the diffusion of hydrogen in metals, depending upon the associated temperature ranges.<sup>42</sup> All limit their representations to interactions of the absorbed hydrogen with the metallic-host lattice: involving electrons, phonons, defects, and either jumping (also known as "hopping") over or quantum-mechanically tunneling through the electrostatic Coulomb barrier separating one interstitial lattice site from another. Classical diffusion involves an activation energy for jumping over the barrier, and thus should predominate at higher temperatures. At the highest temperatures the absorbed hydrogen would occupy energy states above the energy barriers and diffusion would resemble that within a dense gas or liquid, sometimes called a "lattice-gas."

Kehr has asked: "Are mechanisms other than thermally activated jumps over the potential barriers the cause of the large (hydrogen) mobility"? He observes that "not much is known about the detailed interaction of hydrogen with the host metal atoms."<sup>43</sup> And he concludes that a theoretical "derivation of the interaction of a proton with the host metal atoms is urgently needed. This requires the treatment of the screening of a proton in the transition metals (underlining supplied)."<sup>44</sup>

Hydrogen isotopes in palladium exist not as atoms or molecules but as positive ions, screened by clouds of electrons of dimension comparable to that of the Thomas-Fermi screening length,  $D_s$ .<sup>45</sup> At low deuterium concentrations,  $D_s$  has been measured to be as low as  $\sim 0.26 \text{ \AA}$ .<sup>46</sup> The effect of such screening is to reduce the collision cross section of the ion with the palladium crystal nuclei. But the diffusion cross section is dominated by the size of the palladium

---

<sup>5\*</sup> The diffusion coefficient of deuterium in palladium at 100°K is about  $10^{-7} \text{ cm}^{-2} \text{ sec}$ .

**PROPRIETARY DATA**  
For Evaluation Purposes Only

nucleus in comparison with that of the diffusing hydrogen isotope.

I suggest that the palladium nucleus is effectively screened during collisions with hydrogen ions by its postulated neutron skin<sup>6\*</sup> which acts to counteract the palladium's Coulomb electrostatic repulsion by the locally-intense attractive nuclear force exerted by its neutron skin.

Such enhanced nuclear screening of the palladium nucleus I model by employing the Fermi-Thomas equation<sup>7\*</sup> with a correspondingly enhanced screening radius,  $r_{si}$ , appropriate for the palladium atom when scattering a particular hydrogen isotope:

$$V(r) = \frac{Z_p e^2}{r} \exp(-r/r_{si}) \quad (2A)$$

where  $Z_p$  (=46) is the atomic number of palladium;  $r$  is the radial distance from the center of the palladium nucleus;  $r_{si}$  is the effective or enhanced screening radius for a particular hydrogen ion,  $i$ ; and  $e$  the electronic charge.

Equation 2A is an approximation (for radii greater than the peak potential barrier) to the actual net-potential, which would be similar in appearance to eqn. (11) of the main text. The effective neutron-skin enhanced screening radius,  $r_{si}$ , is on the order of  $10^{-11}$  cm, which is to be compared with typical electron-screening values of only  $10^{-8}$  or  $10^{-9}$  cm.

For illustration purposes, fig. 6 compares the Fermi-Thomas exponential approximation (with  $r_{si} = 10^{-11}$  cm) to the net potentials of fig. 2 of the main text. The figure demonstrates that the enhanced-screening Fermi-Thomas equation is a good approximation to the neutron-halo catalyzed net-potential for radii greater than that of the peak barrier potential, which is the region of interest for hydrogen isotope diffusion in palladium.

It follows that the  $r_{si}$  for a deuteron would be smaller than for a proton (a smaller screening-radius corresponding to a larger force), but larger than that for a triton, as the effect of the attractive nuclear force on the net-potential would be more intense the greater the number of the diffusing ion's nucleons. As we shall see subsequently, this realization explains the anomaly associated with eqn. (1A).

To this end, let us treat  $r_{si}$  as a parameter and ask what effect it theoretically should have on hydrogen ion mobility in palladium.

With an absorbed hydrogen-ion concentration,  $\rho$ , and scattering cross section,  $\sigma(r_{si})$ , in palladium, the deuteron mean free path,  $l$ , according to Bohm<sup>47</sup> is given by:

If we consider interstitial jump lengths to reflect the mean free

---

6\* See discussion on page 16.

7\* Note: the Fermi-Thomas equation was employed in earlier drafts of this paper in place, and as an approximation, of eqn. (11) of the present paper.

**PROPRIETARY DATA**  
For Evaluation Purposes Only

$$l = \frac{1}{\rho \sigma(r_{si})} \quad (4A)$$

path, diffusivity is proportional to the square of the mean free path<sup>48</sup>, and thus increases rapidly as the cross section decreases.

The hydrogen-ion/palladium collision cross section (per unit solid angle)<sup>8\*</sup> with a screened Coulomb potential according to Bohm<sup>49</sup> is given by:

$$\sigma_{\theta}(r_{si}) = \frac{4m^2(Z_I Z_P)^2 e^4}{(4p^2 \sin^2 \theta / 2 + \hbar^2 / r_{si}^2)^2} \quad (5A)$$

in which  $m$  is the mass of the hydrogen ion,  $Z_I (=1)$  is the hydrogen ion's atomic number,  $Z_P (=46)$  is the atomic number of palladium,  $\theta$  is the scattering angle,  $\hbar$  is Planck's constant divided by  $2\pi$ ,  $p = (2mE)^{1/2}$  is the ion's momentum expressed in terms of its kinetic energy,  $E$ , and  $r_{si}$  is the ion's (nuclear-enhanced) screening radius in palladium.

Eqn. (5A) shows that the scattering cross section should increase with the square of the atomic number of the diffusing particle, which explains why hydrogen and deuterium diffuse more readily than other elements of necessarily higher  $Z$ . But we also note from (5A) that as  $r_{si} \rightarrow 0$  the cross section rapidly approaches zero<sup>9\*</sup>, with a correspondingly increased mean free path. Thus strong nuclear-enhanced screening would indeed facilitate the diffusion of hydrogen ions in palladium.

Furthermore, as the screening radius of deuterium (because of its additional nucleon) must be smaller than that of hydrogen, deuterium's mobility must be greater than hydrogen's, thus explaining the seeming anomaly with (1A).

An indirect measurement of the hydrogen isotopes' screening radii in palladium may be accomplished by determining that scattering angle which corresponds to the transition from classical to quantum scattering. The quantum-theoretical formula for the scattering cross section per unit solid angle of hydrogen isotopes in palladium is given by equation 5A above. As  $r_{si}$  in 5A approaches infinity (i.e., when there is no screening) the cross section

<sup>8\*</sup> The total collision cross section is obtained by integrating (5A) from  $0$  to  $\pi$ , which may be shown to be given by:

$$\sigma(E) = \frac{\alpha}{\mu[\beta(E) + \mu]}$$

where  $\alpha = 16\pi M_D^2 Z_P^2 e^4$ ,  $\beta(E) = 8M_D E$ , and  $\mu = (\hbar/r_s)^2$ .

<sup>9\*</sup> It would actually approach the  $\pi r_o^2$  cross section of the palladium nucleus, but the argument is unchanged.

**PROPRIETARY DATA**  
For Evaluation Purposes Only

becomes that of classical Rutherford scattering:

$$\sigma_{\theta} = \frac{(Z_I Z_P e^2)^2}{16 E^2 \sin^4 \frac{\theta}{2}} \quad (6A)$$

where  $\sigma_{\theta}$  is now the classical scattering cross section per unit solid angle.<sup>50</sup> Thus to demonstrate the existence of the hypothesized enhanced screening we need only study the angular deviation of the experimental scattering cross sections from the Rutherford law for hydrogen isotopes scattered by palladium.

The cross section given by eqn. 5A for a shielded Coulomb force as a function of the scattering angle,  $\theta$ , initially follows the classical Rutherford law, rising steeply with decreasing  $\theta$  until the two terms of the denominator in eqn. 5A become approximately equal at some particular value,  $\theta_o$ . For yet smaller angles the increase in magnitude of the scattering cross section is comparatively small. The inflection point,  $\theta_o$ , may be regarded as a transition angle below which Rutherford scattering ceases and enhanced screening (depending upon  $r_{si}$ ) thereafter predominates.

The particular value of  $\theta_o$  depends upon both the momentum,  $p$ , of the scattered particles and the effective or enhanced shielding radius,  $r_{si}$ , in accord with the following expression:

$$\theta_o = 2 \sin^{-1} (\hbar / 2 p r_{si}) \quad (7A)$$

for which the two terms in the denominator of eqn. 5A are equal. (For example,  $\theta_o$  is about 8.5 degrees for 300 kev deuterons, if  $r_{si} = 4 \times 10^{-12}$  cm).

Equation 7A can be inverted to estimate the magnitude of  $r_{si}$ , once  $\theta_o$  has been determined experimentally (say, by bombarding a pure palladium foil with a beam of hydrogen ions:

$$r_{si} = \frac{\hbar}{2 \sqrt{2 m E} \sin \frac{\theta_o}{2}} \quad (8A)$$

By setting  $m$  equal to the mass of the hydrogen ion, we then can determine the corresponding screening radii. The magnitude of the  $r_{si}$  will demonstrate the existence *vel non* of nuclear-enhanced screening of hydrogen isotopes in palladium, and correspondingly explain their differing diffusivities.

#### References

1. B. Jonson, "Halo Nuclei," *Nuclear Physics A*, 574, (1994), see also P. G. Hansen, "Exotic edge of nuclear darkness," *New Scientist*, 9 October, (1993).
2. Bailey, et al., *Phys. Rev.* 70, 583, (1946); and D.H. Frisch, *Phys. Rev.* 70, 589, (1946).

**PROPRIETARY DATA**  
For Evaluation Purposes Only

3. H.A. Bethe, *Elementary Nuclear Theory*, 44, Wiley, New York, figure 8 of Chapter IX, (1947).
4. K. Riisager, "Nuclear halo states," *Reviews of Modern Physics*, Vol. 66, No. 3, July, (1994).
5. E. H. S. Burhop et al., "... the existence of a neutron halo in heavy nuclei," *Nuclear Physics A*, 132, (1969).
6. K. Riisager, *op cit*.
7. N. Takigawa & H. Sagawa, "Interaction potential and fusion of a halo nucleus," *Physics Letters B*, 265, (1991).
8. N. Takigawa et al., "Fusion of a halo nucleus ...," *Nuclear Physics A*, 538, (1992).
9. J. D. Cockcroft and E. T. S. Walton, *Roy. Soc. Proc.*, vol 137, p. 229, (1932).
10. M. Born, *Atomic Physics*, 4th Ed., Hafner, N.Y., p. 68, (1946).
11. F. Paneth & K. Peters, "Über die Verwandlung von Wasserstoff in Helium," *Berichte d. Deutschen Chemischen Gesellschaft*, B59, 1926, (also B60, 1927) translated by P. Allison & K. Lockner, Los Alamos Nat. Lab., (1989).
12. A. Fisher, "Much Ado About ...," *Mosaic*, (a publication of the National Science Foundation), 21, No. 2, pp. 12 - 23, (1990).
13. Id.
14. R. Beuhler, G. Friedlander, & L. Friedman, *Physical Review Letters*, 63, 1292, Sept. 18, 1989; also reported as: "Brookhaven Chemists Find New Fusion Method," *Science*, 245, p. 1448, (1989).
15. M. Fleischmann, S. Pons, & M. Hawkins, "Electrochemically Induced Nuclear Fusion of Deuterium," *J. Electroanal. Chem.*, 261, p. 301, 1989, and erratum, 263, p. 187, (1989).
16. J. P. Herson, as reported 2/7/1996.
17. Taken from: *Cold Fusion Research*, A report of the Energy Research Advisory Board to the U.S. Dept. of Energy, p.5, Nov. (1989).
18. N. E. Holden, ed., *CRC Handbook of Chemistry & Physics*, '95 - '96 edition, CRC Press, N.Y. (1993).

PROPRIETARY DATA  
For Evaluation Purposes Only

19. H.A. Bethe, *Elementary Nuclear Theory*, 44, Wiley, New York, eqn. (3), (1947).
20. Bethe, *op. cit.*, eqn. (26), p. 31.
21. *Id.*, pp. 31 - 33, eqn. (29b).
22. *Id.*, p. 33.
23. D. Bohm, *Quantum Theory*, Prentice-Hall, N.Y., p. 226, (1951).
24. Bohm, *op. cit.*, p. 102.
25. N. Takigawa et al, *op. cit.*, (1991) & (1992).
26. Bethe, *op. cit.*, p 61, eqn. (114).
27. Bohm, *op. cit.*, p. 513.
28. J.D. Jackson, *Classical Electrodynamics*, 2nd Ed., Chapter 13, Wiley, N.Y. (1975)
29. *Id.* at p. 629, eqn. (13.44).
30. *Id.*, p. 652, problem 13.2.
31. *Id.*, p.652, prob. 13.1.
32. *Id.*, p. 621, eqn. (13.11).
33. *Id.*, p. 621, eqn. (13.9).
34. Bohm, *op. cit.*, p. 279
35. Bohm, *op. cit.*, p. 513.
36. D.J. Pine and R.M. Cotts, *Physical Review B*, 28, No. 2, 40, (1983).
37. T.P. Papazoglou & M.T. Hepwarth, "The Diffusion of Hydrogen in Titanium," *Trans. Metallurgical Soc. of AIME*, Vol. 242, April, (1968).
38. G. Alefeld & J. Völkl, eds., *Hydrogen in Metals I & II*, Springer-Verlag, Berlin, 1978. See also R. Kirchheim, E. Fromm, and E. Wicke, eds., *Metal-Hydrogen Systems: Fundamentals and Applications*, Vol. 1 & 2, Oldenbourg, Munich, (1988).
39. *Id.*
40. D.G. Westlake, C.R. Satterthwaite, & J.H. Weaver, "Hydrogen in Metals," *Physics Today*, Nov., (1978).

**PROPRIETARY DATA**  
For Evaluation Purposes Only

41. Alefeld & Völkl, op. cit., § 12.5.
42. Id., § 8.
43. Alefeld & Völkl, § 8.1, op. cit. 2. above.
44. Id., § 8.6.
45. A. Burrows, *Physical Review B*, **40**, No. 5, 3405, (1989).
46. Id., at 3406.
47. D. Bohm, op. cit., p. 513, eqn. (2).
48. G.J. Dienes and A.C. Damask, *Point Defects in Metals*, Gordon and Breach, (1963).
49. See endnote 16, *supra*.
50. Bohm, op. cit., p. 538.

New Energy Times

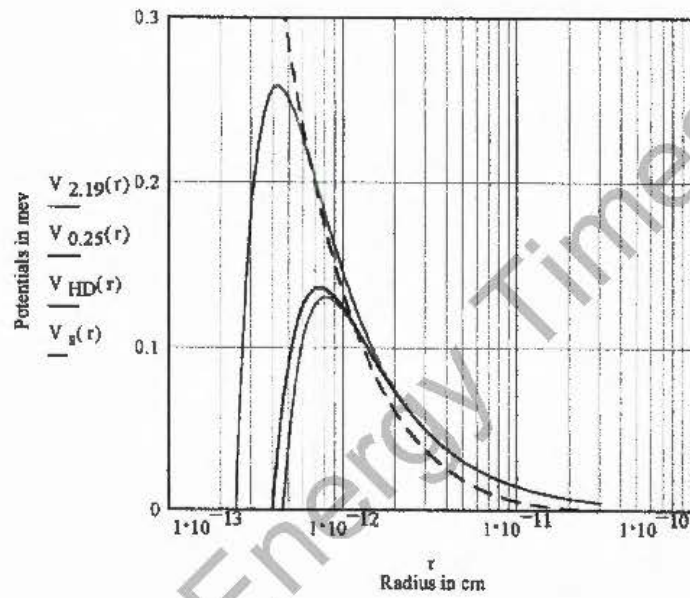

fig 6: Screened-Coulomb Approximation



File - Sponsler.

GEORGE CURTIS SPONSLER  
ATTORNEY AT LAW  
7804 OLD CHESTER ROAD  
BETHESDA, MD 20817-6280  
(301) 320-3431

May 17, 1996

Dr. E. Bickford Hooper  
Assistant Deputy Associate Director  
Magnetic Fusion Energy Program  
Lawrence Livermore National Laboratory  
P.O. Box 808  
Livermore, CA 94551-9900

Dear Dr. Hooper:

Thank you for your letter of April 29. I completely understand that the press of your regular duties has kept you busy and unable as yet to study my triggered-fusion papers. It is really an imposition on your time, and I appreciate and thank you for your help. I trust you will forgive my enclosing yet another paper on the required thickness of the palladium target.

Perhaps there is some other way you could suggest for a review which would not jeopardize my plans to apply for foreign patents. I would be very pleased for a peer review by any qualified people, but I particularly welcome a Livermore review.

Indeed it was in that regard, because of my high regard for Livermore, that I originally wrote your Director, Dr. Tarter. As DOE's Dr. Polansky says, there is none better qualified than Livermore to conduct such a review.

Whoever undertakes the review, there really are only two critical questions to be addressed: (1), Will the incident trigger ion actually acquire a temporary halo-neutron from a palladium lattice atom?; and if so, (2), Will its lifetime be sufficient to assure its subsequent fusion with a thermal deuteron absorbed in the lattice?

As philosopher Karl Popper has observed: it is impossible to prove a theory, only disprove it. If we cannot with certainty answer the foregoing two questions in the negative, then we should undertake the critical experiment I have proposed.

Sincerely,



George C. Sponsler

Enclosure

cc: W. M. Polansky  
C. B. Tarter

PALLADIUM TARGET THICKNESS<sup>1</sup>

In application of triggered-fusion to a practical power cell the basic design problem is that of the thickness of the palladium target: it must be thin enough to permit cooling by heat conduction; but thick enough to provide mechanical rigidity and needed depth to permit sufficient attenuation of the energy of the incident bombarding ion beam. We have seen from fig. 3<sup>2</sup> that an initial 500 kev beam attenuates to 100 kev in 0.06 cm. This latter energy is below that needed to acquire a neutron halo from the palladium target. I therefore somewhat arbitrarily adopt 0.06 cm as the minimum target thickness for triggered-fusion; whatever incident particle energy remains after penetration of palladium of this thickness will be absorbed by the circulating D<sub>2</sub>O (heavy-water) coolant.

Both the conduction of heat and the diffusion of deuterium in palladium are represented mathematically by the diffusion equation,

$$\nabla^2 \psi = \text{const} \frac{\partial \psi}{\partial t}, \quad (1)$$

where *const* is the coefficient of diffusion, *C*, or of conductivity,  $1/\kappa$ , respectively. I treat the palladium target as a thin slab in which case (1) reduces to  $\partial^2 \psi / \partial x^2 = \text{const} \partial \psi / \partial t$ , in which *x* is the direction normal to the slab face.

I assume the concentration of deuterons at the face of the (deuteron-saturated) palladium target adjacent to the D<sub>2</sub>O coolant is the same as the palladium density,  $1.6 \times 10^{22}$  per cc. According to table 1<sup>3</sup>, an average of  $1.7 \times 10^{12}$  fusions per sec are required to generate one watt for the D + D reaction resulting from a proton trigger, and  $3.5 \times 10^{11}$  per sec for the T + D reaction resulting from a deuteron trigger. One ampere of ion beam current requires a flow of  $6.2 \times 10^{18}$  singly-charged triggers per sec. And finally, the melting point of palladium is 1549°C with a specific gravity of 12.16 as a solid.

If *r* fusion reactions per second are required for one watt output, then an ion gun producing *F* watts of fusion power requires *rF* fusions per second. In the steady state, I model the rate of depletion of deuterons absorbed in the palladium target as the effective withdrawal of same from the side of the palladium target facing the ion-gun beam, resulting in a diffusive flow of absorbed deuterons from the side of the target facing the D<sub>2</sub>O coolant toward that facing the impingent beam gun producing *F* watts of fusion power, with a single-ion probability of fusion,  $P_f$ , produces a total of  $nP_f = rF$  ions

---

<sup>1</sup> Appendix to "Neutron-Halo Catalyzed Triggered-Fusion," by George C. Sponsler.

<sup>2</sup> All figures refer to the preceding main text.

<sup>3</sup> All tables refer to the main text.

**PROPRIETARY DATA**  
For Evaluation Purposes Only

fusing each second (out of a total beam-intensity of  $n$  ions per second), corresponding to  $rFV_b/6.2 \times 10^{18} P_f$  watts of total beam power (where  $V_b$  is the beam accelerating voltage). Therefore, the total power,  $W$ , (both kinetic/thermal and fusion) produced by an ion beam producing  $F$  watts of fusion power is given by  $W = F[1 + rV_b/6.2 \times 10^{18} P_f]$ , which, upon solving for  $F$ , yields:

$$F = \frac{W}{\left[ 1 + \frac{rV_b}{6.2 \times 10^{18} P_f} \right]} \quad (2)$$

Thus from (2), of an ion-gun beam producing a total of  $W$  watts,  $F$  watts result from fusions.

If  $\rho$  is the concentration of deuterons absorbed in the palladium target, as with any diffusion equation the flux,  $J$ , of deuterons per  $\text{cm}^2$  per second passing perpendicularly to the target face is given by:

$$J = -\frac{1}{c} \frac{\partial \rho}{\partial x} \quad (3)$$

In the steady-state, as  $\partial \rho / \partial t = 0$  then  $\nabla^2 \rho = 0$  and hence  $\partial \rho / \partial x = \text{const} = (\rho_2 - \rho_1) / l$ , where  $\rho_2$  and  $\rho_1$  are the deuteron concentrations at the two faces of a target of thickness  $l$ .

Letting  $\rho_2 - \rho_1 = \Delta$ , as  $J = rF$  it follows that:

$$W = \frac{\rho \Delta}{rCl} \left[ 1 + \frac{rV_b}{6.2 \times 10^{18} P_f} \right] \quad (4)$$

For illustration, if we take  $l = 0.06$  cm,  $V_b = 500$  kv, and  $W = 1$  kW, then  $\Delta$  is  $3.78 \times 10^{13}$  deuterons per  $\text{cm}^2$  for proton triggers or about  $2.34 \times 10^{-7} \%$  of the maximum concentration. For deuteron triggers, the corresponding numbers are  $1.74 \times 10^{13}$  and  $1.08 \times 10^{-7} \%$ , respectively. The implicit assumption of the main text that the deuteron concentration is essentially constant throughout the palladium target is thus validated.

Turning to heat conduction, the primary restriction on cell power-production is the melting point of palladium:  $1554^\circ\text{C}$ . I calculate the maximum heat (both fusion-generated and kinetic/thermal) which can be produced that results in that temperature at the face of the target exposed to the ion beam. I assume the  $\text{D}_2\text{O}$  coolant temperature is  $100^\circ\text{C}$  which in the steady state produces a temperature gradient (opposite in direction to the deuterium-concentration gradient) of  $1454/l$   $^\circ\text{C}$  per cm with a palladium-target slab thickness of  $l$  cm. In what follows, the specific heat,  $c$ , of palladium is taken to

**PROPRIETARY DATA**  
For Evaluation Purposes Only

be 0.0584 cal/gm; its thermal conductivity,  $K$ , is 0.18 cal cm per  $\text{cm}^2$  per sec per  $^{\circ}\text{C}$ ; and its density,  $\rho_{Pd}$  12.01 gm/ $\text{cm}^3$ .

Although I have calculated the absorbed deuteron concentration gradient for a slab target, in a practical triggered-fusion power cell I conceive of the palladium target as actually being a spherical cap (concave toward the ion gun) of radius  $r$  and chord width  $2w$ , which protrudes slightly within the wall of the  $\text{D}_2\text{O}$  coolant pipe into which the power cell is affixed (i.e. screwed). The corresponding temperature gradient is, nevertheless, approximately that of a flat slab, and the thermal conductivity equation completely analogous to (1), with  $r$  replacing  $x$  and  $T$  being the temperature:

$$\frac{\partial T}{\partial t} = \kappa \frac{\partial^2 T}{\partial r^2}, \quad \text{where } \kappa = \frac{K}{\rho_{Pd}c} \quad (5)$$

In the steady state, once again  $\partial T/\partial t = 0$  and  $\partial T/\partial r = \text{const} = \Delta T/l$ , where  $\Delta T$  is the temperature difference between the two faces of the palladium target of thickness  $l$ .

Completely analogous to the flux of absorbed deuterons (but again with reversed direction), the maximum heat flux permitted by the melting point of palladium is given by:

$$J_{\text{max}} = -K \frac{\Delta T}{l} = \frac{1095}{l} \text{ watts/cm}^2, \quad (6)$$

since 1 cal/sec equals 4.184 watts. For a cell to operate at 10 kW per  $\text{cm}^2$ , the target must therefore be no thicker than 0.11 cm; for it to operate at 1 kW/ $\text{cm}^2$  the thickness could be increased to 1.1 cm.

The tensile stress in a thin spherical shell filled with a fluid at pressure  $p$  is approximated by<sup>1</sup>:

$$s_t = \frac{pr}{2l} \quad (7)$$

If we assume the compressive stress in such a shell, created by the same but now exterior pressure, is approximated by this same formula, we can estimate that stress in the spherical-cap shaped palladium target exerted by the pressurized  $\text{D}_2\text{O}$  coolant on the target's exposed (concave) face.

The tensile strength of palladium runs from 21,000 to 60,000 psi, depending upon its treatment. A 0.11 cm thick target, by equation (7), would experience a compressive stress of 23,091 psi within a spherical-cap target with a 2 inch radius of curvature. As compressive strength is greater than tensile strength, a 0.11 cm thick palladium target therefore should be able to operate in a reactor with

**PROPRIETARY DATA**  
For Evaluation Purposes Only

D<sub>2</sub> O coolant pressure of 1000 psi or less operating at 100°C.

As we have seen above, a 0.11 cm thick, spherical-cap palladium target has a maximum permissible heat flux of 10 kW/cm<sup>2</sup>. Such a spherical-cap palladium target with a half-chord,  $w$ , of one inch and a radius of curvature of two inches could produce a maximum of 243 kW (since its area is equal to  $2\pi rw$ ). If a practical triggered-fusion reactor were to operate for safety at, say, 100 kW per cell, a 100 gW power reactor would require 1000 such cells for maximum load.

**Reference**

1. S. Timoshenko and G. H. MacCollough, Elements of Strength of Materials, Van Nostrand, New York, p. 51, 1940.

New Energy Times



File-Sponsler

# Lawrence Livermore National Laboratory

April 29, 1996

Dr. George Sponsler  
Attorney at Law  
7804 Old Chester Road  
Bethesda, Maryland 20817

Dear Dr. Sponsler:

Thank you for your letters and the report. I have been extremely busy and have not yet had time to look at it carefully. When I get a chance I will study the work and respond to you.

As I have noted before, I still feel it is important to get a detailed peer review. Almost any funding source is likely to insist on this. I understand your concerns about patents, but urge you to seek a means of protection that will allow publication.

Respectfully yours,

A handwritten signature in black ink that reads "E. Bickford Hooper".

E. Bickford Hooper  
Assistant Deputy Associate Director  
Magnetic Fusion Energy Program

cc: W. M. Polansky  
C. B. Tarter

File

**GEORGE CURTIS SPONSLER**  
**ATTORNEY AT LAW**  
**7804 OLD CHESTER ROAD**  
**BETHESDA, MD 20817-6280**  
**(301) 320-3431**

May 10, 1996

Walter M. Polansky, Director  
Division of Advanced Energy Projects, ER-16  
Department of Energy  
Washington, D.C. 20585

Dear Walt:

Several times this week I have tried to phone you, but your secretary tells me you have been quite busy and have not yet been able to return my calls. I need to speak with you about my recent correspondence with Livermore Laboratory, copies of which have been provided you.

As Bickford Hooper wrote on April 29, he too has been quite busy and has been unable to review my Triggered-Fusion papers I forwarded him and you under cover of my letters of March 14 and April 17. He would, however, still like an external peer review to support his owned planned review.

I want to speak with you about the possibility of your providing such a review, possibly as a pre-proposal response to the experimental verification I am trying to persuade Livermore to undertake.

The problem is that, as philosopher Karl Popper has observed, it is impossible to prove a theory, only disprove it. In my case, this fact is augmented by the concern that triggered-fusion is cold-fusion in disguise. It isn't, as I show in the enclosure to my letter of March 14; but decision-makers need reassurance before they recommend the proposed experiment.

Please phone me.

Sincerely,



George Sponsler

Sponsler

George Curtis Sponsler  
ATTORNEY AT LAW

7804 OLD CHESTER ROAD, BETHESDA, MARYLAND 20817  
TELEPHONE 301/320-3431

September 29, 1995

Dr. E. Bickford Hooper  
Assistant Deputy Associate Director  
Magnetic Fusion Energy Program  
Lawrence Livermore National Laboratory  
P.O. Box 808 L-637  
Livermore, CA 94551-9900

Dear Dr. Hooper:

Thank you for your thoughtful and detailed response of September 20, 1995 to my letter to you of August 29, 1995. I agree with most of your observations, but see I failed to describe adequately both my patent concerns and, more importantly, my palladium nuclear catalyst hypothesis.

First patents: as you say, publication of my theory in the open literature would not affect my pending U.S. patent application (unless it were rejected and had to be revised and resubmitted), but it would preclude issuance of foreign patents not as yet applied for. My plan is to make such applications immediately upon the hoped-for successful conclusion of the needed experiment before publication thereof.

As for my palladium nuclear catalyst theory the key question is the existence and lifetime of the "activated" triton. I hypothesize the trigger deuteron captures an outlying neutron from a palladium lattice atom which is presumed to possess an extended neutron "skin." I further presume the neutron is captured as a short-lived (NOT long-lived) halo. Half-lives of some halo neutrons have been measured to be on the order of milliseconds: more than enough time for a subsequent fusion with an absorbed deuteron, even after further intervening collisions with other palladium atoms and with energy dissipated by lattice electrons. The effect of the trigger's halo neutron is to increase both the collision cross section and the probability of fusion with another, absorbed deuteron.

I believe a palladium neutron skin is likely to exist as it would explain the extraordinary diffusive mobility of hydrogen isotopes in palladium. Neither titanium nor zirconium display such enhanced diffusivity; presumably they therefore would not possess such skins and so would not display the enhanced fusion of absorbed deuterium postulated for palladium. And insofar as the existence of hydrogen



isotope halos is concerned, the deuteron itself is considered normally to be in a pre-halo state.

You are quite right, however; I have not adequately treated theoretically the entire nuclear catalyst process. I only conceived it this summer in response to John Perkin's suggestion of the need for a physical mechanism to explain triggered fusion. The principal problem is I do not know how to calculate the capture probabilities of both the skin and halo neutrons, including the conservation of energy and momentum. Could you refer me to an appropriate text or other source for such guidance?

Finally, would such an extended calculation be adequate to persuade Livermore to undertake the needed experiment? I plan to initiate the theoretical extensions this Fall, and later publish as you suggest, if I can handle the patent problem. But I would like the assurance that Livermore might undertake the experiment, when and if I can meet your quite legitimate concerns.

Sincerely,

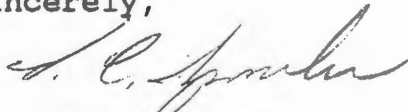

George C. Sponsler

cc: W. M. Polansky  
C. B. Tarter

New Energy Times

1425 OCT 19 10 24 AM

Sponsler

# Lawrence Livermore National Laboratory

September 20, 1995

Dr. George C. Sponsler  
Attorney at Law  
7804 Old Chester Road  
Bethesda, Maryland 20817

Dear Dr. Sponsler:

Thank you for your letter dated August 29, 1995 in which you ask: "Will LLNL undertake the needed experiment?" Following receipt of this letter, I have further reviewed your manuscript *Triggered-Fusion*, sent to Dr. Tarter in your earlier letter.

I am concerned about the highly speculative nature of the mechanisms you propose. As I understand your discussion, two nuclear reactions in series are required in the putative fusion process:

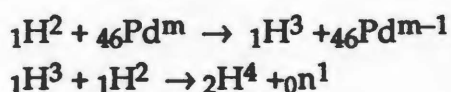

In the first step, the stable palladium isotopes have  $102 \leq m \leq 110$ . Similar processes are assumed to occur if the initial deuteron is replaced by a proton or  $\text{He}^3$  nucleus. Because the probability of the series process is the product of the two probabilities, both must be relatively large to compete with a single-step fusion mechanism.

You suggest that the neutron captured in the first reaction is loosely bound to the palladium ( $\sim 250$  keV) in a "halo" or "skin" and that, therefore, the effective radius of the palladium nucleus may be greater than  $10^{-12}$  cm. Your model for the cross section for capture estimates it to be 14 times the usual DD fusion cross section ( $< 0.1$  barn), so that this process is more probable than fusion.

- The probability of fusion in the absence of capture is quite small, so your conclusion (page 20) that the fusion process is dominated by this process implies the probability of the second step is  $> 1/14$  if your concept is indeed correct. (Competing processes, such as further collisions with the palladium are not estimated, nor is this implicit claim compared quantitatively with losses to the lattice electrons.)
- You have not demonstrated conservation of both energy and momentum in the capture process; it would seem unlikely that they are both balanced in a long-range collision process such as you postulate. In the heavy nucleus fusion processes you reference (your references 30-31) the result is a fusion of the incoming nucleus with the target (e.g.  $\text{Li}^A + \text{U}^{238} \rightarrow \text{U}^{238+A}$ ), and the energy balance includes vibrational modes of the final nucleus. I don't see how this could be important for your process at energies so far below the



Recycled

coulomb barrier.

- The halo nuclei are all unstable, so far as I know; how does the excitation occur in your model?

In any event, it appears that the probabilities you list, e.g. in Table 4, are those *required* for the fusion to produce power rather than ones *calculated* using a model based either on fundamental principles (without undetermined parameters) or on experimental data.

You also hypothesize that the triton formed by the neutron capture is "activated," and in a long-lived, excited state with the captured neutron in a halo.

- I am unaware of any long-life excited states of the triton [c.f. C. M. Lederer and V. S. Shirley, (eds) *Table of Isotopes*, 7th Ed., (John Wiley and Sons, N.Y., 1978)], and find it hard to believe that they would not be known.
- The review paper on halo nuclei (your ref. 26) lists the hydrogen isotopes among those not predicted to have halos; what is your basis for the claim?

The hypothesized triton, in turn, is expected to reduce the effective coulomb barrier thereby significantly enhancing the fusion cross section.

There is no data presented to support any of the postulated processes.

- You recognize that the cold fusion results are "questionable;" I personally doubt many of the claims of cold-fusion enthusiasts.
- The conclusions resulting from the cluster bombardment at Brookhaven were withdrawn rather more thoroughly than implied in their erratum [Phys. Rev. Letters 68, 2108 (1992)]. In a later publication [Y. K. Bae, et al., Phys. Rev. A 48, 4461 (1993)] they indicate that there is no enhancement using D<sub>2</sub>O clusters, and about a factor of two using H<sub>2</sub>O clusters striking a deuterated target. Fusion with this process is attributed to knock-on processes.
- Bombardment of tritiated and deuterated titanium by deuterium beams [L. J. Perkins, et al., Nucl. Sci. and Engr. 78, 30 (1981)] and of tritiated zirconium by deuterium beams in the Rotating Target Neutron Source here at LLNL showed no enhancement of the fusion reaction over that predicted by conventional slowing down in a deuterated or tritiated metal lattice.

I thus know of no experimental results to lead me to believe that nuclear processes in a palladium or other metal matrix are not explained by more conventional processes. In such cases, the fusion energy gain, i.e. the ratio of fusion power produced to incident beam power, is typically  $\sim 10^{-4}$ , i.e. much less than unity.

On a more practical matter, Dr. Walter M. Polansky of the Department of Energy has informed me that any proposal will have to go through a full evaluation process, including peer review; I believe that you received a copy of his letter to me. My concerns about your postulated processes are probably shared by others; I would thus anticipate that even if I agreed with your hypotheses a proposal would need considerable work, with corresponding expense, before it would have a reasonable chance of acceptance.

Because of these many issues and concerns, I am unwilling to support a proposal from LLNL to carry out the experiment you propose and unwilling to recommend that LLNL undertake the experiment. I continue to believe that the proper process for you to follow is to use the publication procedure with accompanying peer review. I am not a lawyer or expert on the patent process, but my understanding is that you are protected once a patent has been applied for. You should consult an expert, but if I am correct you could pursue the publication process once you have made the application for the process patent.

I regret that my response to your request is negative, but I have applied my best scientific judgment to my evaluation. I hope that my comments will be useful to you and that your future work is fruitful.

Respectfully yours,

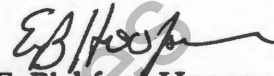

E. Bickford Hooper  
Assistant Deputy Associate Director  
Magnetic Fusion Energy Program

EBH/gd

cc: C. B. Tarter

W. M. Polansky

New Energy Times

file

George Curtis Sponsler

ATTORNEY AT LAW

7804 OLD CHESTER ROAD, BETHESDA, MARYLAND 20817  
TELEPHONE 301/320-3431

July 3, 1995

Dr. L. John Perkins  
Lawrence Livermore National Laboratory  
P.O. Box 808 L-1  
Livermore, CA 94551

Dear John,

Would you please arrange an early September meeting for me with yourself, Alex Glass, Carla Lewis and whoever in authority is authorized to approve preparation of a LLNL proposal for an experimental test of my triggered-fusion theory.

Such an experiment need not endorse my theory, but only agrees that it merits such a test. To date, no one has disproved it. If it is right, we have a new source of energy and an explanation of hydrogen diffusion in palladium. If wrong, you would have demonstrated nuclear-enhanced screening does not exist.

LLNL stands to benefit either way. Furthermore I believe Walt Polansky of DOE would welcome such a proposal: the proposed funding level is reasonable, and the results scientifically valuable, whatever they may prove to be. Let's do it!

Sincerely,



George C. Sponsler

cc: A.J. Glass  
C. Lewis  
W. M. Polansky

SEP 06 1995

Dr. E. Bickford Hooper  
Assistant Deputy Associate Director  
Magnetic Fusion Energy Program  
Lawrence Livermore National Laboratory  
P.O. Box 808, L-637  
Livermore, CA 94551-9900

Dear Dr. Hooper:

I am taking this opportunity to respond to a letter dated August 29, 1995, that you received from Mr. George C. Sponsler. The last paragraph in that letter suggests that the Advanced Energy Projects Division would fund Mr. Sponsler's experiment if a proposal were submitted by a reputable laboratory and that proposal passed peer review. Satisfying these criteria alone does not necessarily lead to funding.

The Advanced Energy Projects Division (AEP) provides support to explore the feasibility of novel, energy-related concepts that evolved from advances in basic research and are at an early stage of scientific definition. The Division also supports high-risk, exploratory concepts that do not readily fit into a DOE program area but could have applications that may span scientific disciplines or technical areas.

Projects arise from unsolicited ideas and concepts submitted by researchers. The average funding level for an AEP project is \$300,000 and the funding period is typically three years or less.

Awards are based on the results of an evaluation process which includes peer review. The enclosed booklet, "Application Guide for the Office of Energy Research, Financial Assistance Program, 10 CFR Part 605," describes review and evaluation procedures for unsolicited proposals, which are usually submitted by universities, research organizations and individuals. As a matter of policy, AEP uses the same evaluation process for submissions from the National Laboratories.

ER-33  
2 W  
WMPolansky/ses  
9/5/95

If you would like to discuss this matter further, do not hesitate to contact me. My telephone number is 301-903-5995.

Sincerely,

Walter M. Polansky, Director  
Advanced Energy Projects Division  
Office of Computational and Technology  
Research

Enclosure

cc:  
G.C. Sponsler (w/enc.)  
C.B. Tarter, LLNL

New Energy Times

George Curtis Sponsler  
ATTORNEY AT LAW

7804 OLD CHESTER ROAD, BETHESDA, MARYLAND 20817  
TELEPHONE 301/320-3431

August 29, 1995

Dr. E. Bickford Hooper  
Assistant Deputy Associate Director  
Magnetic Fusion Energy Program  
Lawrence Livermore National Laboratory  
P.O. Box 808 L-637  
Livermore, CA 94551-9900

Dear Dr. Hooper:

Thank you for your courteous response of August 23, 1995 to my earlier letter to Dr. Tarter.

Please be assured I am totally familiar with the scientific peer review process. I hold a Ph.D. in Engineering Physics from Princeton University; I am a Fellow of the American Physics Society; I was Chief Scientist of the U.S. Navy Bureau of Ships; Director of IBM's Center for Exploratory Studies; Executive Secretary of the National Academy of Sciences' National Research Council Division of Engineering; President of my own R&D consulting firm; and most recently, as a Congressional Fellow, science adviser to Senator Paul Simon.

My problem is a Catch-22: were I to publish my theory in the open literature that disclosure would prevent issuance of the process patent for which I have applied. Furthermore, ultimately only the proposed experiment will prove Triggered-Fusion operability.

Will LLNL undertake the needed experiment? You needn't endorse my theory, only agree that it is plausible and deserves testing. I believe Dr. Walter Polansky, Director of DOE's Advanced Energy Projects Division, stands ready to fund the experiment provided it is proposed by a reputable laboratory and that proposal passes DOE's peer review.

Sincerely,



George C. Sponsler

cc: W. M. Polansky  
C. B. Tarter

?  
Bad Statement



*George Curtis Sponsler*  
ATTORNEY AT LAW

7604 OLD CHESTER ROAD, BETHESDA, MARYLAND 20817  
TELEPHONE 301/320 3431

April 11, 1995

Dr. Alexander J. Glass  
VIA FAX: (510) 653-4803  
Lawrence Livermore National Laboratory  
P.O. Box 808 L-1  
Livermore, CA 94551

Dear Alex:

Thank you for your help in contacting John Perkins. I was pleased to learn that John is still with us, and I hope he will soon complete his promised review of my triggered-fusion physical mechanism. I have enclosed my latest revision of the latter with this letter, copy of which I am sending John.

Meanwhile, I would like to encourage you to arrange the meeting about which I wrote you March 27. Livermore has much to gain, whether or not the needed experiment validates my theory, and I hope we can make mutually satisfactory arrangements to undertake the proposed investigation.

Sincerely,

  
George C. Sponsler

cc: L. J. Perkins

cc: W. Polinsky (DOF) ←

PROPRIETARY DATA  
For Evaluation Purposes Only

### III. Physical Mechanism

The prior theory of triggered-fusion has been based on the explicit assumption that the potential of the incident trigger particle, exhibited during its collisions with thermal deuterons absorbed in a saturated palladium target, may be represented by the Fermi-Thomas equation (15) with unusually intense effective screening ( $r_s = 10^{-12}$  cm). Hereafter, and in the Appendix, I argue that the actual potentials of both the trigger and the palladium reflect the net effect of the nuclear Coulomb electrostatic repulsion reduced by the strong attractive nuclear-force which, it is hypothesized, may extend beyond the classical nuclear radius as a result of neutron skins, pre-halos, and halos.

The term "screening" as used heretofore is *prima facie* a misnomer: the effective reduction of the electrostatic Coulomb barrier is not accomplished by atomic orbital electrons as with conventional screening but rather, as hypothesized, by the attractive nuclear force associated with a neutron skin or halo. Hereafter I suggest a possible physical mechanism for triggered-fusion envisioned as a two-step process, both dependent upon neutron skins or halos: an initial trigger activation, followed by a subsequent fusion of the activated trigger with a thermal deuteron absorbed in the palladium target.

I theorize that the activation is a result of the trigger particle capturing, if only briefly, via a nuclear reaction a loosely-bound neutron from the neutron-skin postulated to surround palladium nuclei. The trigger particle may either retain or lose that neutron, but in either event the trigger itself is left in an excited state with its own valence neutron loosely bound.

Use of the term "screening" therefor is not a complete misnomer for both neutron nuclear halos and skins, especially for the latter. Both lie outside the nuclear protons and do indeed effectively act to counteract the latter's repulsive electric field to the extent of their own attractive nuclear fields.

A halo is a general phenomenon common to loosely bound particles in short-range potential wells. Such particles can tunnel quantum-mechanically into the space surrounding the nuclear potential well. Halos may thus increase the nuclear radius by factors of ten to twenty or more.<sup>1</sup> In the relevant energy ranges, halos involve a nuclear core with usually one or at most two valence neutrons and display the strength of a single-particle with a low separation energy. Typical neutron halo separation energies are of the order of 0.25 to 0.5 mev.<sup>1\*</sup>

There is ample evidence which substantiates the hypothesis that the nuclear potential may extend beyond the classical radius of the deuteron and of other atoms. For example, a protruding or shoulder potential of this form was shown by Bohm and Richman in 1946 to fit the experimentally observed scattering cross section of neutrons by free protons.<sup>2</sup> Bethe presents that potential as fig. 8, reproduced herewith<sup>3</sup>.

---

<sup>1\*</sup> Experimentally, though less common than neutron halos, proton halos have also been observed.

( PROPRIETARY DATA )  
For Evaluation Purposes Only

Place figure 8 about here.

It is also now well established that neutrons as halos may orbit the core of a nucleus, penetrating beyond the wall of the nuclear potential well.<sup>4</sup> As neutrons are carriers, as it were, of the nuclear force, such halos are completely analogous to penetration by the nuclear force beyond the classical nuclear radius.

Usually, halos (and hence their associated fields) are short lived. But there are similar, stable nuclei which exhibit long lifetimes: so-called "pre-halos," exemplified by the deuteron itself; and "neutron-skin" nuclei, such as silver<sup>5</sup>, wherein the bulk of the neutron density extends further from the nuclear center than does the proton density. Halo neutrons may be both captured or lost by decay, and excited-state halos are also possible.<sup>6</sup>

Empirically, the nuclear radius,  $r_0$ , of a nucleus composed of  $A$  nucleons is given by:<sup>7</sup>

$$r_0 = 1.5 \times 10^{-13} A^{1/3} \text{ cm} \quad (1)$$

This equation assumes the nucleons are uniformly distributed over a sphere of radius  $r_0$ , and therefore does not apply to haloed nuclei. For example, the normal (pre-halo) deuteron nuclear radius is actually about twice that given by eqn. (21).<sup>2\*</sup>

As discussed hereafter in section IV, in order for useful amounts of electric power to be generated from D/D or p/D fusions the trigger particle's peak effective or net Coulomb barrier potential should be no more than about one-third (1/3) to perhaps as little as one-tenth (1/10) the experimental value of 260 kev for the free deuteron. I suggest this potential reduction accompanies an enlargement of the effective nuclear radius of the trigger which in turn reflects the orbital location of the trigger's excited valence neutron. The combination of reduced barrier potential and enlarged nuclear radius results in increased fusion probability.

Takigawa and Sagawa in 1991 were the first to suggest that the neutron halo might facilitate fusion reactions.<sup>8</sup> They showed that "the fusion cross section of a halo nucleus is drastically enhanced at low energies because of the lowering of the fusion barrier and the coupling of the translational motion to soft (dipole vibration) modes of excitation associated with the (valence) neutron halo." As elucidated in a subsequent paper<sup>9</sup>, they calculate a huge enhancement of up to four orders of magnitude of the fusion cross section at neutron separation energies of 0.2 mev.

Heisenberg's Uncertainty Principle may be used to estimate the nuclear potential function in the vicinity of a halo or valence

<sup>2\*</sup> The maximum Coulomb barrier potential of the deuteron experimentally is about 260 kev, corresponding to a nucleon radius of about  $4 \times 10^{-13}$  cm.

( PROPRIETARY DATA )  
For Evaluation Purposes Only

neutron. Following Bohm<sup>10</sup>, it takes a momentum  $p = \hbar/\Delta x$ , and hence an energy  $E = p^2/2m = \hbar^2/2m(\Delta x)^2$  to keep a nucleon of mass  $m$  localized within a region  $\Delta x$ . This momentum creates a pressure, which tends to resist localization of the nucleon. The pressure is opposed by the nuclear force of attraction which holds the nucleus together. The valence neutron orbital radius is determined by the equilibrium point where the nuclear force balances the effective pressure. That balance point is determined by the condition that the total energy,  $W$  (kinetic plus potential), must be a minimum.

If we let  $W = \hbar^2/2m(\Delta x)^2 + E_n$ , where  $E_n$  is the nuclear potential seen by a halo neutron, and set the partial derivative of  $W$  with respect to  $\Delta x$  equal to 0, we see  $E_n = -\hbar^2/2m(\Delta x)^2$ . For a halo neutron,  $\Delta x$  is equivalent to its orbital radius,  $r$ . Therefore the nuclear potential seen by a valence neutron may be approximated by the formula:

$$V_n(r) = -\frac{\hbar^2}{2mr^2} \quad (2)$$

This formula does not recognize that the valence neutron energy levels must be quantized (being given by the eigenvalues of the appropriate Schrödinger wave equation) but rather are assumed to be continuous. The approximation is correspondingly inexact and should be treated as giving only bounding or limit values.

The conclusion that the nuclear attractive force field in the region of the neutron halo may be approximated by a  $1/r^2$  potential is partially corroborated by the work of Takigawa et al<sup>11</sup> who represent the density of the halo or valence neutrons by the formula:

$$\rho(s) = \rho_0(\kappa) \frac{e^{-2\kappa s}}{s^2} \quad (3)$$

where  $s$  is the distance between the center of the valence neutrons and that of the core of the projectile, and the diffuseness parameter,  $\kappa$ , is related to the separation energy,  $\sigma$ , of the valence neutrons. For a haloed deuteron,  $\kappa$  is given by:

$$\kappa = \sqrt{\frac{m\sigma}{\hbar}} \quad (4)$$

Because of the short range of the strong nuclear force, it is reasonable to assume that the potential created by a neutron halo should closely resemble the shape of the neutron density, given by eqn. (3). As a better approximation of that potential, I therefore replace (2) by the following formula:

$$V_n(r) = -\frac{\hbar^2 e^{-2\kappa r}}{2mr^2} \quad (5)$$

As will be seen, (5) reduces to (2) when  $\sigma = 0$ .

( PROPRIETARY DATA )  
For Evaluation Purposes Only

The net potential near the nuclear well of a deuteron, with a single valence neutron of mass  $m$ , seen by a proton is then given by the sum of the Coulomb,  $V_c$ , and attractive nuclear,  $V_n$ , potentials:

$$V(r) = \frac{e^2}{r} - \frac{\hbar^2}{2mI^2} e^{-2kr} \quad (6)$$

Figure 9 presents this net potential for the nuclear potential derived from the Heisenberg uncertainty principle (i.e. for the potential of eqn. 2, or from eqn. 5 with  $\sigma = 0$ ). As will be seen, the corresponding  $V_{max} = 51$  kev at  $r_m = 1.4 \times 10^{-12}$  cm. Figure 10 gives the potential for an inactivated deuteron (i.e.,  $V_{max} = 267$  kev,  $r_m = 4 \times 10^{-13}$  cm) with  $\sigma = 1.2$  mev.<sup>3\*</sup>

Place figures 9 and 10 about here.

Although eqn. (6) is heuristic, assuming it does represent the potential of a haloed nucleus it is apparent that the effect of the halo is to expand the nuclear radius to perhaps  $10^{-12}$  cm (depending upon the valence neutron separation energy,  $\sigma$ ) corresponding to a maximum barrier potential on the order of 50 kev. Production of practical electrical power by a triggered-fusion generator should therefore be feasible, provided the production of sufficient quantities of activated triggers is also feasible.

However, before considering this question it should be noted that the Fermi-Thomas equation has been used in the preceding theory of triggered-fusion simply as a mathematically convenient approximation for the combined Coulomb and nuclear potentials. The appropriate value of the screening radius,  $r_s$ , to be used when employing the Fermi-Thomas equation to approximate the actual potential may be determined by equating the Fermi-Thomas equation to the combined potential maximum,  $V_m$ , at  $r = r_m$ , giving:

$$r_s = \frac{-r_m}{\ln\left[\frac{r_m V_m}{e^2}\right]} \quad (7)$$

For example, the potential of fig. 8, with the shoulder terminated at  $6 \times 10^{-13}$  cm. producing a ten percent reduction of the maximum Coulomb barrier, results in an  $r_s = 4 \times 10^{-12}$  cm.

We thus see it is reasonable to use the Fermi-Thomas equation with a necessarily small screening radius to approximate the net combined Coulomb and nuclear potentials in the vicinity of its maximum. Using that formula we previously have demonstrated that an activated trigger offers a sufficiently large probability of fusion

<sup>3\*</sup> For  $\sigma = 200$  kev,  $V_{max} = 154$  kev, and  $r_m = 6.6 \times 10^{-13}$  cm.

( PROPRIETARY DATA )  
For Evaluation Purposes Only

with a deuteron absorbed in palladium to yield practical amounts of useful power. Let us then consider trigger activation.

I hypothesize that the activation mechanism is analogous to the inelastic scattering of incident neutrons by a target nucleus of charge  $Z$  and atomic number  $A$ , but with the roles reversed. That is: the projectile is the trigger particle ( $p$ ,  $D$ , or  ${}^3\text{He}$ ) while the target is the palladium neutron skin or, more precisely, one of the neutrons constituting the skin which is postulated to surround the palladium nucleus. Since that skin is external to the protons of the palladium nucleus, it seems likely, particularly at the comparatively low to intermediate kinetic energies with which we are here involved, that the positively charged trigger would interact with a valence neutron beyond the palladium's maximum Coulomb barrier, rather than fuse with the entire nucleus.

The conventional inelastic scattering reaction

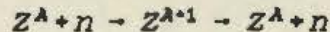

is thus replaced, for a deuterium trigger, by

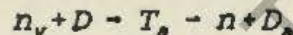

where the subscript  $a$  refers to an activated or excited nucleus, and  $T$  is a deuteron with an additional neutron (i.e. an excited triton).

All nuclear reactions produce internal excitation energy which may be reduced by evaporating neutrons. But even after a neutron is evaporated, the residual nucleus may still be left, at least temporarily, in an excited state.<sup>12</sup> This latter excited state, or the excited compound-nucleus leading to it, is what I term activation of an incident trigger.

With a deuteron, activation would correspond, possibly, to an excited triton or, probably, to an excited deuteron with a more energetic valence neutron. Since the deuteron is normally in a pre-halo neutron state, the effect of activation would be to increase even further the halo-induced nuclear radius to that corresponding to the reduced separation energy of the excited neutron.

The activated state might be short lived, but would probably be longer than the interval (on the order of  $10^{-13}$  to  $10^{-12}$  sec) between activation and a subsequent fusion with a thermal-energy deuteron absorbed in the palladium.

The cross section for the inelastic encounter between the trigger and the palladium neutron skin, by eqn. (1) would be proportional to the square of the cube-root of the palladium nuclear radius. Thus the ratio of that activation cross section to the cross section for a subsequent fusion with a thermal deuteron would be given by:

where  $A_{pd}$  is the palladium nucleus mass number ( $\sim 106$ ), and  $A_t$  is the mass number of the trigger.

For a deuteron trigger we see from (30) that the probability of activation is about 14 times greater than the probability of a D/D fusion. It follows that it is correspondingly more likely that

( ) PROPRIETARY DATA ( )  
For Evaluation Purposes Only

$$\frac{\sigma_a}{\sigma_f} = \sqrt{\frac{A_{Pd}}{A_t}} \quad (30)$$

the trigger will indeed have been activated prior to the fusion, which itself becomes more probable as a result of the prior activation.

The situation is slightly different with a proton trigger. Strictly speaking, the intermediate compound nucleus with a proton trigger would be a deuteron because of the captured valence neutron (just as the deuteron trigger became a transient triton). But there now is the possibility that the proton's transient state might become permanent: that is, the trigger proton becomes an excited deuteron. In this latter event, the analysis of a proton trigger becomes essentially the same as with a deuteron trigger.

It seems probable that a proton trigger would indeed become an excited deuteron: the neutron capture cross section for a proton is 100 times greater than for a deuteron. Furthermore, the probability of capture of slow neutrons by protons is independent of the relative velocities of the two particles.<sup>13</sup> Consequently, activation of a proton or deuteron trigger is essentially the same, both yielding an activated deuteron.

The situation is different with helium-three. The  $\kappa$  diffuseness parameter of Takigawa and Sagawa would be slightly greater (by a factor of  $[4/3]^{1/2}$ )<sup>14</sup>. But more importantly, there is the question of whether or not the  $^3\text{He}$  trigger might permanently capture a Pd skin neutron, thereby creating  $^4\text{He}$  which would not subsequently fuse with a thermal deuteron.

This is not to say, however, that the possible chain reaction of page 12 would also abort: the  $^3\text{He}$  generated in such a chain would be excited, and hence activated, simply as a result of the nuclear reaction which resulted in its creation. An excited  $^3\text{He}$  could then continue the chain reaction with correspondingly enhanced probability. Experimentation is demanded.

Indeed, experiments are needed to test both these proposed physical mechanisms and the very existence of triggered-fusion itself. The simplest experiment would be to bombard a deuterium-saturated palladium target with 300 keV to 3 MeV deuterons to see if the number of fusions generated were substantially greater (e.g. by a factor of  $10^4$ ) than would be expected in the absence of the palladium catalyst. Should such prove to be the case, proton and  $^3\text{He}$  triggers could then be substituted and the experiment repeated.

#### REFERENCES

1. B. Jonson, "Halo Nuclei," *Nuclear Physics A*, 574, (1994), see also P. G. Hansen, "Exotic edge of nuclear darkness," *New Scientist*, 9 October, (1993).

( PROPRIETARY DATA )  
For Evaluation Purposes Only

2. Bailey ,et al., *Phys. Rev.* 70, 583, (1946); and D.H. Frisch, *Phys. Rev.* 70, 589, (1946).
3. H.A. Bethe, *Elementary Nuclear Theory*, 44, Wiley, New York, Chapter IX, (1947).
4. K. Riisager, "Nuclear halo states," *Reviews of Modern Physics*," Vol. 66, No. 3, July, (1994).
5. E. H. S. Burhop et al., " . . . the existence of a neutron halo in heavy nuclei," *Nuclear Physics A*, 132, (1969).
6. K. Riisager, *op cit.*
7. H.A. Bethe, *Elementary Nuclear Theory*, 44, Wiley, New York, eqn. (3), (1947).
8. N. Takigawa & H. Sagawa, "Interaction potential and fusion of a halo nucleus," *Physics Letters B*," 265, (1991).
9. N. Takigawa et al., "Fusion of a halo nucleus . . .," *Nuclear Physics A*," 538, (1992).
10. Bohm, *op. cit.*, p. 102.
11. N. Takigawa et al, *op. cit.* p. 222c, (1992).
12. Bethe, *op. cit.*, p. 114.
13. *Id.*, p. 62.
14. *op. cit.*, eqn. (3), p. 24, (1991)



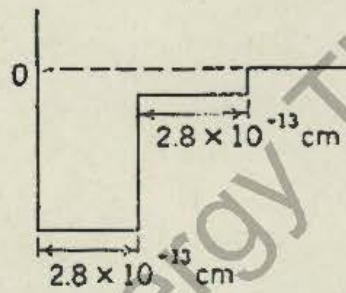

FIG. 8. Potential well of the deuteron giving the best fit to scattering experiments.

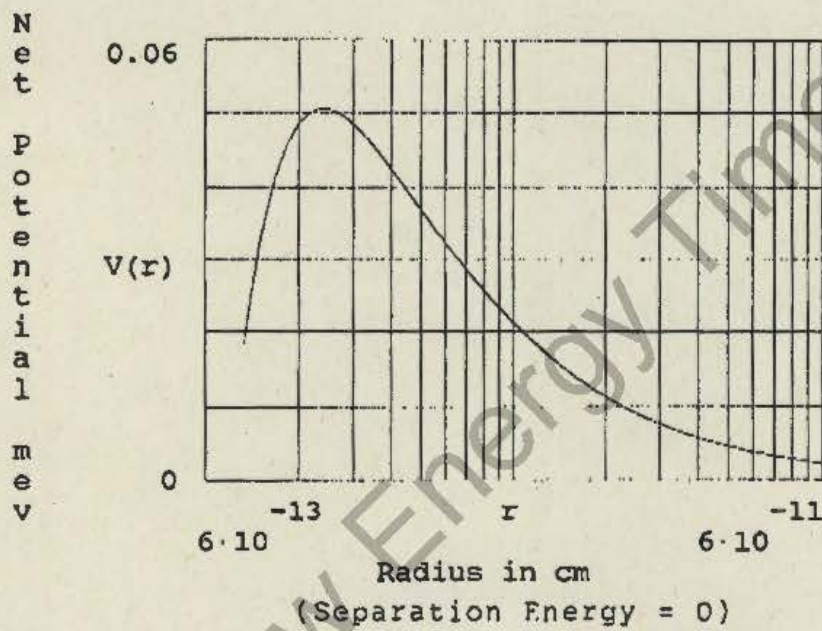
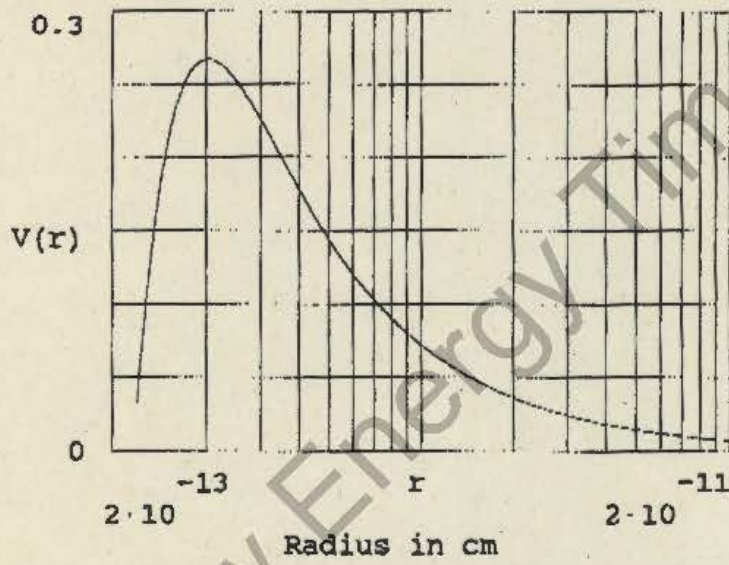

Figure 9

Net  
P  
o  
t  
e  
n  
t  
i  
a  
l  
  
m  
e  
v



(Separation Energy = 1.2 meV)

Figure 10

File

George Curtis Sponsler  
ATTORNEY AT LAW

7804 OLD CHESTER ROAD, BETHESDA, MARYLAND 20817  
TELEPHONE 301/320-3431

September 28, 1994

Dr. John Perkins  
Lawrence Livermore National Laboratory  
P.O. Box 808 L-1  
Livermore, CA 94551

Dear John:

I have revised my triggered-fusion theory by restricting the incident trigger particles to those "fairly-direct" collisions needed to permit fusions, which in turn requires the fusion cross section to be that of the deuteron nucleus,  $\sigma=4\pi r_o^2$ , with radius  $r_o$ . The following table presents a sample of results, which illustrate how very sensitive the cumulative fusion probabilities,  $P_f$ , are to both the deuteron nuclear radius and to the screening radius,  $r_s$ .

$r_o$ ( $\times 10^{-13}$ ) cm	$r_s$ ( $\times 10^{-13}$ ) cm	$E_t$ (kev)	$P_f$
4	12	260	0.01
2	2	260	0.004
8	12	93	0.102
4	2	47	0.083
8	4	25	0.448

As before, the analysis only pertains to palladium-like matrices offering high hydrogen-isotope diffusion mobilities; titanium (with a mobility  $10^{-6}$  that of palladium) is not included. I shall incorporate all these changes in a revision of my prior papers, which I plan for mid-November after my return from a trip abroad.

It is particularly important to recognize that my "screening radius" is simply that number which, incorporated in the Fermi-Thomas equation, results in the corresponding maximum potential,  $E_t$ , at the edge of the nuclear well. For example, your experimental 260 kev deuteron peak potential at  $r_o = 4 \times 10^{-13}$  cm corresponds to  $r_s = 1.2 \times 10^{-12}$ ; a figure much smaller than that resulting from electron screening, and supporting my hypothesis that the lower than Coulomb-predicted peak potential must be the result of nuclear (in this case, self-) screening.

J. Perkins,  
September 26, 1994  
Page 2.

Even with the "fairly-direct" collision revision, practical power generation by triggered-fusion theoretically is still possible with palladium-enhanced screening, if the generator efficiency is sufficiently high and if the screening is sufficiently strong. The question is thus still, as before: what is the actual palladium screening of deuterium?

As best I can determine, no one has measured the probability of fusion of a single high-energy deuteron bombarding a thick deuterium-saturated palladium target. (I phoned your friend at Amersham, but they are out of the business and could not help). George Chambers at the Naval Research Laboratory plans to submit a proposal to DOE to simulate my theory on their computer and then test it experimentally. But I am sure we all would welcome an independent experimental measurement of the cumulative fusion probability by Livermore; could you do it? Please advise.

Sincerely,



George C. Sponsler

cc: G.Chambers (NRL)  
W. Polansky (DOE)

New Energy Times

File.

George Curtis Sponsler  
ATTORNEY AT LAW

7804 OLD CHESTER ROAD, BETHESDA, MARYLAND 20817  
TELEPHONE 301/320-3431

June 27, 1994

Walter M. Polansky  
Director,  
Division of Advanced Energy Projects, ER-16  
Department of Energy  
Washington, D.C. 20585

Dear Walt,

Since last writing you and Dr. Glass, further evidence has come to hand which tends to substantiate my theory of nuclear enhanced screening outlined on pages 4 and 5 of my paper, "Experimental Measurement of Enhanced Screening of Hydrogen Isotopes in Palladium." I suggest that the nuclear potential must extend beyond the classical radius of the deuteron in the near vicinity of the nuclear well, leading to the constant-value approximation expressed by equation 7 of that paper.

A potential of precisely this form was shown by Bohm and Richman in 1946 to fit the experimentally observed scattering cross section of neutrons by free protons (Bailey, et al., *Phys. Rev.* 70, 583, 1946; D.H. Frisch, *Phys. Rev.* 70, 589, 1946). H.A. Bethe (*Elementary Nuclear Theory*, 44, Wiley, New York, 1947) presents the potential as fig. 8 of Chapter IX, enclosed herewith. As I explain in my paper, such a potential is entirely equivalent with nuclear enhanced screening.

I am also herewith copying George Chambers of the Naval Research Laboratory, who I believe will serve as Principal Investigator of their amended proposal. I now believe there is every reason to test experimentally the existence of enhanced screening, with its implications for a new source (Triggered-Fusion) of nuclear power.

Sincerely,



George C. Sponsler

cc: G. Chambers (NRL)  
A. Glass (LLNL)

enc.

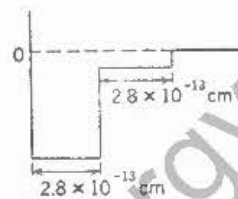

FIG. 8. Potential well of the deuteron giving the best fit to scattering experiments.

New Energy Times

File

George Curtis Sponsler  
ATTORNEY AT LAW

7804 OLD CHESTER ROAD, BETHESDA, MARYLAND 20817  
TELEPHONE 301/320-3431

June 23, 1994

Dr. Alexander J. Glass  
Lawrence Livermore National Laboratory  
P.O. Box 808, L-1  
Livermore, CA 94551

Dear Dr. Glass:

Our mutual friend, Bill Culver, has referred me to you as the person at Livermore responsible for identifying promising new fusion projects. Enclosed herewith are two proprietary papers of mine describing a new concept of "Triggered-Fusion" on which I have been working for the past several years. The first paper, "Triggered-Fusion," presents the mathematical theory of the new process. The second, "Experimental Measurement of Enhanced Screening of Hydrogen Isotopes in Palladium," is an argument for believing that enhanced screening, hypothesized by the triggered-fusion theory, also explains certain experimental hydrogen diffusion properties and anomalies, lending credence to its existence. A patent application is currently under review by the Patent Office.

Colleagues at the Naval Research Laboratory have proposed an experimental test of my theory to Walt Polansky, DOE Director, Division of Advanced Energy Projects. His DOE reviewers, without objecting to my theory, rejected the NRL proposal on the basis that the required screening, as yet unmeasured, would have to be much greater than conventional electronic screening. I agree with the DOE reviewers, and wrote the second paper in answer to their criticism. Walt Polansky has indicated he will reconsider an amended NRL proposal directed to an experimental measurement of the actual screening of deuterium in palladium and other metals.

Walt Polansky and I would both welcome Livermore's involvement in the needed experiments, by your providing either joint funding or other assistance. We also would welcome your candid critique of my two papers. Please let me hear from you.

Sincerely,



George C. Sponsler

cc: W. Culver (w/o enc)  
W. Polansky (w/o enc)  
encs.



George Curtis Sponsler

ATTORNEY AT LAW

7804 OLD CHESTER ROAD, BETHESDA, MARYLAND 20817  
TELEPHONE 301/320-3431

September 2, 1993

Dr. Edmond Storms  
Box 270 Hyde Park Estates  
Sante Fe, N.M. 87501

Dear Ed,

As we discussed on the telephone, Future Energy Applied Technology, Inc. has thoroughly and favorably reviewed my Triggered Fusion papers: *Triggered-Fusion Power Generation*, and *Triggered-Fusion*, copies of which are enclosed. Fred Jaeger, F.E.A.T. President, also tells me his scientists believe the feasibility experiment, now needed to test my theory, would be ideal for government sponsorship.

As you also know, Gerry Hale of Los Alamos National Laboratory previously had also reviewed my mathematical paper. I think we all agree it would be appropriate for Los Alamos to undertake the critical experiment. The question becomes: will Los Alamos commit the necessary Cockcroft-Walton generator and associated facilities and manpower to conduct the experiment under your leadership as Principal Investigator?

I envision a three-party joint venture between my company, Law Mathematics and Technology (LMT), Inc., F.E.A.T., and DOE/Los Alamos. Walt Polansky, DOE Director of Advanced Energy Projects, says DOE headquarters might be able to provide some \$300,000 toward the experiment. Jaeger says F.E.A.T. might be able to provide \$75,000 plus management support. I am uncertain if this latter would include your reimbursement as Principal Investigator and mine as Project Director; though I would contribute my time, if I were reimbursed for expenses and given sufficient funds or in-kind support to amend my current US patent application and to gain the needed foreign patents for triggered-fusion.

Edmond Storms,  
September 2, 1993  
Page 2.

Would you please explore this entire matter with the appropriate people at Los Alamos. I particularly would like to know what their own contribution might be, assuming they would want to participate. Will we have sufficient funds to conduct the needed experiment? I will look to you to make the necessary investigations and, if promising, to draft the formal proposal for DOE.

The joint venture could be headed by any of the three institutions involved, but Walt Polansky tells me different funding mechanisms would be required if Los Alamos were to lead the project. Were F.E.A.T. or LMT to lead, DOE would employ a Special Research Grant; if Los Alamos were to lead two other approaches might be used, but both would probably require much longer time to process. I feel F.E.A.T. would be the best choice, because of their financial responsibility. We would need to spell-out very carefully the commercial benefits for all parties, especially the patent-license arrangements.

Finally, I have also enclosed a Non-disclosure and Confidentiality Agreement to be executed by an appropriate party at Los Alamos in return for which you may copy and provide them a copy of my enclosed triggered-fusion papers.

I believe this to be a very promising project; I hope Los Alamos agrees.

Sincerely,



George C. Sponsler

enc.

cc: F. Jaeger (w/o enc.)  
W. Polansky (w/o enc.)

1993 SEP -3 B 5:13

File

From: Walt Polansky  
Date: 6/21/93 3:31 PM  
Priority: Normal  
TO: Duane Barney  
C Sue-Ellen Stottlemeyer  
C Walt Polansky  
Subject: Inquiry from Sponsler

----- Message Contents -----

Duane-

We have a letter of inquiry from George <sup>P</sup>Sonsler. Would you take a close look at it so we can discuss the appropriate response ?

Thanks.

Walt P.

P.S. Sue Ellen has the incoming.

*Duane.*  
*Incoming attached*  
*Sue Ellen*

6/23  
Talked to Sponsler.  
He'll get back to  
Jensen & (or) Storms.  
to cast-out the experiment.  
W/

George Curtis Sponsler  
ATTORNEY AT LAW

7804 OLD CHESTER ROAD, BETHESDA, MARYLAND 20817  
TELEPHONE 301/320-3431

June 14, 1993

Walter M. Polansky, Director  
Division of Advanced Energy Projects, ER-16  
Department of Energy  
Washington, D.C. 20585

Dear Walt:

Thank you for the Application Guide for the Office of Energy Research Financial Assistance Program. When we spoke, you also suggested I write an informal letter outlining the design and benefits of the experiment I want to propose; this is that letter.

Enclosed is a general description of my triggered-fusion invention, the feasibility of which I want to test experimentally. Please treat this information as proprietary as it extends beyond my patent application which is still pending.

The proposed feasibility experiment is quite simple in concept, if perhaps expensive to undertake. I would like Los Alamos to do the following:

- (1) Design and build an experimental electrolytic cell, saturated with deuterium, like the one sketched in the enclosure, with an ion gun attached as shown therein.
- (2) The ion gun would be charged by a Cockcroft-Walton generator operating at about 300 keV, as per the diagram.
- (3) The gun would direct protons or deuterons against the cell's palladium target, again as per the diagram. (Protons would be preferable in a practical electric power generator as neutrons would not be created as with the deuteron reaction).
- (4) Using computer-controlled instrumentation, the heat developed by the triggered fusion would be measured calorimetrically in the electrolytic cell, and the corresponding power compared with the total power input. According to my calculations, the output power should be about seven times the input.

Ed Storms has informally agreed to run the experiment. He tells me a staff of six would be required for six months. With Los Alamos overhead, such an experiment would cost about one million dollars, according to Reed Jensen.

W. M. Polansky,  
June 14, 1993,  
Page 2.

I am in a quandary as to just how to propose funding for the experiment. I would prefer that DOE, were it to support my proposal, simply advance the necessary funds for the actual experiment directly to Los Alamos, rather than having Los Alamos subcontract the work from my company, Law Mathematics and Technology Incorporated. Yet I, as President of LMT, want to direct the project; I don't want to serve simply as a consultant to Los Alamos, even were Ed Storms the Los Alamos Principal Investigator. I would work half-time, charging \$50,000 to \$60,000 plus expenses for the six month period, and would be willing to waive any profit (from the experiment alone, that is) as my company's contribution to the project, were that necessary. Would you please advise me how I should proceed?

As regards anticipated benefits were the experiment to succeed, a trillion dollar global market is no exaggeration for a practical triggered-fusion electric power generator. The nuclear reaction itself is intrinsically safe (particularly with proton triggering). Practical engineering development problems would remain, but a successful triggered-fusion feasibility experiment quite literally would herald the beginning of the end of the age of fossil fuels.

Sincerely,



George C. Sponsler

enc.

New Energy Ventures

PROPRIETARY DATA  
For Evaluation Purposes Only

TRIGGERED-FUSION POWER GENERATION

by

George C. Sponsler, Ph.D., J.D.

To date the practical use of fusion power has been limited to hydrogen bombs. Peaceful electric power generation has not yet been attained, though many countries are experimenting with various thermonuclear reactor prototypes such as the "Tokamak," ITER (International Thermonuclear Experimental Reactor), and laser-fusion reactors.

Most thermonuclear reactors envision controlled nuclear fusion of deuterium and tritium, both isotopes of hydrogen. Deuterium is found naturally in water with a concentration of about 1 part in 5000; this "heavy water" is easily separated electrochemically. Tritium is far less common, and is also radioactive.<sup>1</sup>

The problem with conventional thermonuclear reactor proposals is that all the deuterium and tritium fusion candidates must be held tightly together at millions of degrees temperature long enough for the needed fusions to take place spontaneously, as it were. To date this goal has eluded all experimenters, employing both magnetic and inertial confinement.

From the standpoint of an individual deuteron the physical obstacle to fusion is that presented by the Coulomb electrostatic repulsion barrier with its peak potential of about three hundred thousand electron volts. To fuse with the nucleus of a second deuteron, (or any other positively-charged particle, such as a proton), the first must pass over or (quantum-mechanically, tunnel through) this Coulomb barrier. In conventional thermonuclear reactors the needed energy would be provided by compressing and simultaneously heating all the deuterons and tritons.

An appealing alternative approach would be to trigger initial fusions by bombarding some rather than all of a volume of room-temperature deuterons with a beam of, say, three hundred thousand electron-volt (keV) deuterons. The high-energy particles resulting therefrom might then collide with yet other deuterons, producing secondary fusions. These latter fusions might then in turn produce tertiary fusions in a similar manner, and so on, leading to a chain of such repeating fusions.

The accompanying mathematical theory<sup>2</sup> demonstrates that such a process is indeed to be expected in a deuterium-saturated palladium target. Furthermore, the resulting chain reactions do not expand numerically after initial triggering, but probably terminate

---

<sup>1</sup> A somewhat different, "Aneutronic," approach employing a small <sup>3</sup>He-fusion reactor (called a "Self-Collider") is under development by a USA-Russia research consortium.

<sup>2</sup> G. C. Sponsler, "Triggered-Fusion," (1993).

**PROPRIETARY DATA**  
**For Evaluation Purposes Only**

after at most only four or five successive fusion generations. Thus there could be no explosion, and the power thereby released would be controlled by limiting the number of triggering deuterons. This process is what I call "triggered-fusion."

Mathematically, as the trigger particle's energy decreases the cross section (probability of collision) increases in the energy range from hundreds to tens of kev. Numerical calculations show that the most desirable range of cross sections correspond to energies below the Coulomb barrier peak energy. But the probability of penetrating the Coulomb barrier also decreases with decreasing energies below the peak barrier potential.

There is, therefore, a tradeoff: at lower energies the probability of penetrating the barrier is lower, but the cross section (collision probability) is higher. Numerical calculations indicate that, for deuterons absorbed in palladium, a relative energy range extending from about ten thousand electron volts to three hundred thousand electron volts gives the greatest combined probability of fusion by pairs of deuterons.

Palladium offers several potential benefits for triggered fusion. First, deuterium easily diffuses through palladium which can be saturated with deuterons in a one to one ratio with the total number of palladium crystal atoms. Second, the palladium nuclei are surrounded by relatively dense clouds of electrons: 46 electrons for each palladium atom, most bound but a few free. The effect of the electron clouds is rapidly to decelerate the passage of any charged particle, thereby resolving the problem of reducing the triggered-fusion product-particles' high energies. Palladium also possesses certain other desirable properties, such as a high melting point and good electrical conductivity.

The theory from which was derived the concept of triggered-fusion hypothesizes that palladium also exhibits electron screening of the Coulomb barrier potential to a greater degree than other metals. By electron screening is meant the effective interposition of electrons between positively-charged nuclei within the palladium crystal: either between the palladium nuclei and absorbed deuterons or between pairs of absorbed deuterons. Although the electrons move very fast, on the average an electron may be considered to be located between two positive nuclei, reducing the mutual electrostatic repulsion of the latter: hence the term "screening."

Strong screening effectively reduces both the "tail" and the "peak" of the Coulomb barrier potential. Mathematically, strong screening would account for the high, so-called, "mean-free-path" of deuterons in palladium, explaining the relative ease of diffusion of deuterium through palladium. The existence of strong screening is amenable to proof by scattering experiment: large angular-deviations from classical or "Rutherford" scattering are indicative of strong screening.

Imagine now a single high-energy deuteron incident upon a palladium crystal saturated with deuterons. The incident particle will lose energy in a mathematically predictable fashion as it passes through the electron clouds surrounding the palladium crystal nuclei. From time to time it will bounce off a palladium

**PROPRIETARY DATA**  
**For Evaluation Purposes Only**

nucleus in an elastic (energy-conserving) collision. These collisions are of practical importance, for without them the incident particle would fly straight through a thin target. With the clouds, more than half the incident particles will quickly be brought to rest, at distances of at most only a few millimeters from the crystal surface. However, some of the incident deuterons will collide and fuse with absorbed deuterons. The probability of such fusions is mathematically calculable.

Occasionally, and more rarely, a chain of successive fusions will be triggered. But the mathematically-calculable probability of the length of such chains rapidly decreases between successive fusions, such that it would be extremely rare for there to be more than four or five fusions in a particular chain. Of course the total number of fusions can be increased (controlled) simply by increasing the number of initial triggering particles.

Assuming an initial deuteron trigger, four possible seemingly different fusion chains could be ignited. But closer inspection will indicate there really are only two. Furthermore, as neutron reactions with the palladium-absorbed deuterons are improbable, only a single chain of alternating fusions of protons and helium-three ( $^3\text{He}$ ) particles with absorbed deuterons is likely, whether initiated by either the  $^3\text{He} + n$  or the  $T + p$  branch.

Theory shows that the average energy released by all the chain-reaction fusions generated by a single initial 300 kev deuteron trigger would total about seven and one-half to ten times the energy of the trigger particle, depending upon how frequently which of the two possible nuclear branches actually initiates the process.

Because of mechanical and electrical losses, the amount of useful electricity generated by a practical triggered-fusion electrical generator might be less than even five times the total triggering energy; but at least a two or three to one ratio of useful fusion output to ion beam energy should surely be attainable. And since the needed ion beam input power could be "fed back" from the generated output, that energy would be "recycled," that is added to the fusion-generated energy. Additional input power would only be needed, initially, to start a practical triggered-fusion generator, and to compensate for steady-state ion beam losses.

A single triggered-fusion electric power generator-cell could be designed in many ways, but all would have certain aspects in common: (1) a beam of triggering deuterons, accelerated to about 300 kev (by, say, a Cockcroft-Walton electrostatic generator for start-up purposes, or by transformer feedback from the generator output in an operating electric power-generator); (2) a thin palladium target, probably a hollow tube, bombarded by the deuteron trigger beam on one (out)side and containing circulating heavy water on the other (in)side (providing both the deuteron "targets" absorbed by the palladium as well as serving to carry away the generated heat to an external heat-exchanger); (3) a (central) charging electrode (wire) held at a few volts positive to induce the deuterons from the heavy water to diffuse into the palladium tube.



**PROPRIETARY DATA**  
**For Evaluation Purposes Only**

Place figure about here.

Such a cell is diagrammed in the accompanying Figure I, which depicts an ion gun directing its beam of 300 kev deuterons through an evacuated tube against the exterior of a thin palladium pipe through which circulates a stream of heavy-water ( $D_2O$ ).

Provision would be needed to prevent the escape of, and where necessary to recapture, any deuterons which diffused completely through the pipe wall. Prevention might be accomplished by a thin coating, on the exterior of the pipes beyond the ion beam impingement areas, of some metal which inhibits deuteron diffusion. Any captured deuterium would be recombined with electrolyzed oxygen to recreate more heavy water (thereby also gaining a small additional increment of heat energy).

The circulating heavy water serves two functions. First, it provides a steadily replaced supply of thermal deuterons which are attracted to the palladium tube by the electric field created by the centrally-mounted low-voltage positively-charged wire. The thermal deuterons diffuse through the wall of the palladium tube and become targets for the triggering ion beam. The heavy-water also conducts the fusion-generated heat away from the cell to the heat exchanger.

Multiple cells could be fabricated by mounting several ion guns around a particular circumference of a single palladium pipe, with similar circumferential mountings both above and below. An operating triggered-fusion electric power generator might contain thousands of individual cells, hundreds of which might be attached to a single palladium pipe-section.

The total number of ion guns required would, of course, be determined by the maximum total electrical power output desired divided by the power generated per ion gun. Neglecting losses, if the maximum factor of ten ratio between ion beam input and fusion power output were attainable for a single cell, a one kilowatt generator output would be triggered by a 100 watt, 300 kev, ion beam with a beam current of only one-third milliamp.

A sturdy containment shield would protect the entire generator against chemical explosion or escape of neutrons generated by some of the triggered-fusion reactions.<sup>3</sup> And an external heat exchanger would be attached to a conventional turbo-electric or other power generator. More unconventional generators, such as solid-state thermoelectric converters, might be used in place of the heat exchanger/turbo-generator set, were comparable thermal efficiencies attainable.

The thin-wall palladium - or similar metal, such as titanium - pipe is the key to the operation of the triggered-fusion power

<sup>3</sup> Note: if protons, rather than deuterons, were employed for the triggering ion beam, no neutrons would be generated!

PROPRIETARY DATA  
For Evaluation Purposes Only

generator. Physically it separates the heavy water - the coolant fluid and target-deuteron source - from the high-voltage deuteron ion gun beam, while simultaneously facilitating diffusion of the heavy-water deuterons to the outer pipe wall ion-beam impingement area. The palladium also conducts the generated heat away from this outer wall target area to the interior coolant heavy-water. The palladium electrons, which attenuate the energy of both incident and fusion-generated particles, prevent the possibility of a runaway chain reaction. And the enhanced electron-screening hypothesized for the palladium catalyzes the fusion reaction by increasing the quantum mechanical transmissivity (Coulomb barrier penetration probability)<sup>4</sup>, and also produces a greater collision cross section<sup>5</sup> than is found experimentally with gaseous or liquid  $D_2O$ .<sup>6</sup>

Triggered-fusion would thus appear to offer a practical source of electrical power generation by the controlled fusion of deuterium ions.

---

4 Id., eqn. (19).

5 Id. eqn. (12).

6 Note: the so-called screening radius,  $r_s$ , may be and probably is different for the deuteron/palladium collision cross section, which controls the mean free path of the deuterons absorbed within the palladium, from what it is for deuteron/deuteron collisions which affects their fusion probability within the palladium.

# Heavy-Water from Heat Exchanger

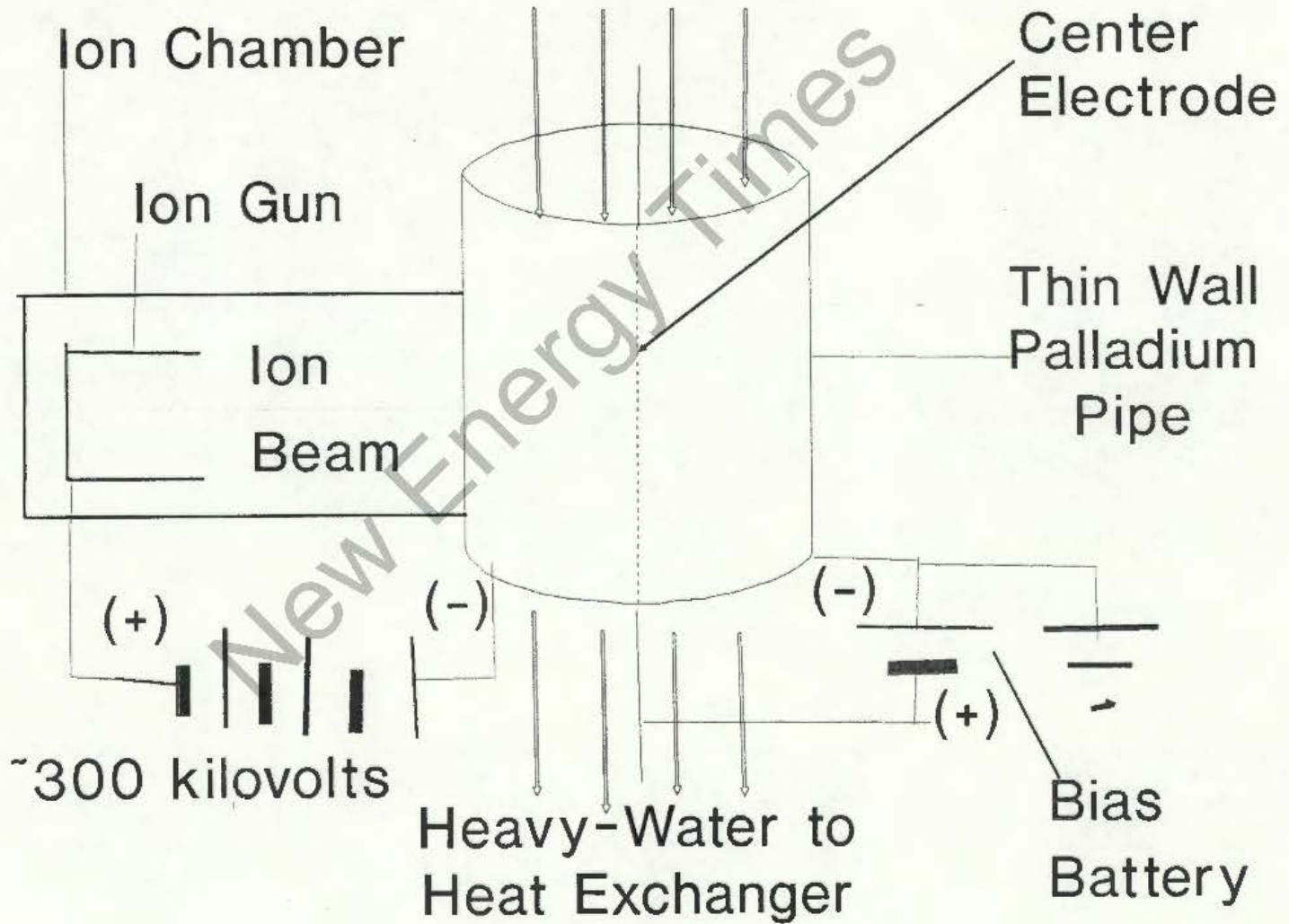

Figure 1

File

George Curtis Sponsler  
ATTORNEY AT LAW

7804 OLD CHESTER ROAD, BETHESDA, MARYLAND 20817  
TELEPHONE 301/320-3431

May 10, 1993

Margaret M. Todd  
Manager-Submitted Ideas  
Corporate Legal Staff  
General Electric Company  
3135 Easton Turnpike  
Fairfield, CT 06431

Dear Ms. Todd:

Thank you for your May 4 response to my April 20 letter to Mr. Welch, but my letter was misdirected to "Submitted Ideas." My proposal is more of the nature of a joint venture between GE, the U.S. Government Department of Energy, and my company, Law Mathematics and Technology Incorporated. More specifically, I propose that GE, in return for a license to pending and future patents held by me, would fund a critical experiment of my triggered-fusion theory to be conducted by the Los Alamos National Laboratory.

Reed Jensen, Associate Director of Los Alamos, advises me the needed experiment will cost on the order of one million dollars. However, according to Walter Polansky, Director of DOE Advanced Energy Projects, there is a possibility DOE headquarters might fund one half of the cost to Los Alamos. I would serve as consultant to the experiment, to be reimbursed by GE.

Obviously, GE could not consider such an arrangement without careful study of my triggered-fusion theory. But were the proposed experiment to be successful, it would open a trillion dollar market and mark the beginning of the end of the age of fossil fuels. It is for this reason that I offer GE the right to study my theory in return for a non-disclosure and confidentiality agreement. But, as you will appreciate, some trade secret agreement is essential.

I hope we can reach such an agreement, as I believe there could be much to be gained by everyone involved.

Very truly yours,

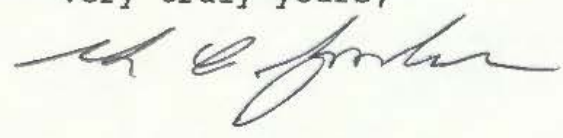

George C. Sponsler

cc: R. Jensen  
W. Polansky  
J. F. Welch

George Curtis Sponsler

ATTORNEY AT LAW

7804 OLD CHESTER ROAD, BETHESDA, MARYLAND 20817  
TELEPHONE 301/320-3431

April 14, 1993

Reed Jensen  
Associate Director  
Los Alamos National Laboratory  
Mailstop B-243  
Los Alamos, NM 87545

Dear Dr. Jensen,

Since writing you on April 6, for promotion purposes I have written a "popularized" description or executive summary of my triggered-fusion power generation concept: a copy is enclosed. On the assumption that I am able to incorporate Gerry Hale's latest suggestion into my theory, I believe triggered-fusion power generation will prove to be feasible.

I hope you will be able to support the proposed experimental test, and will phone you next week to discuss how we might proceed.

Sincerely,



George C. Sponsler

cc: W. Polansky

enc.

**PROPRIETARY DATA**  
**For Evaluation Purposes Only**

**TRIGGERED-FUSION POWER GENERATION**

by

George C. Sponsler, Ph.D., J.D.

To date practical use of fusion power has been limited to hydrogen bombs. Peaceful electric power generation has not yet been attained, though many countries are experimenting with various thermonuclear reactor designs.

Most such thermonuclear reactors envision nuclear fusion of deuterium and tritium, both isotopes of hydrogen. Deuterium is found naturally in water with a concentration of about 1 in 5000; this "heavy water" is easily separated electrochemically. Tritium is far less common, and is also radioactive.

The problem with conventional thermonuclear reactors is that all the deuterons and tritons must be held tightly together at millions of degrees temperature long enough for the needed fusions to take place. So far this goal has eluded all experimenters.

From the standpoint of an individual deuteron the physical problem is that presented by the Coulomb electrostatic potential barrier: looking rather like a volcano when plotted mathematically in three dimensions, its peak potential corresponds to hundreds of thousands of electron volts. To fuse with the nucleus at the center of the "volcano" a second deuteron, or other singly positive-charged particle ( for example, a proton) must pass over or (quantum-mechanically, tunnel through) this Coulomb barrier. In thermonuclear reactors the corresponding energy is initially provided by compressing and simultaneously heating all the deuterons and tritons.

Conceptually, an alternative approach would be to trigger an initial fusion by bombarding a room temperature volume of deuterium heavy water or higher-temperature gas (steam) with a beam of high energy (say, several hundred thousand electron volt) deuterons. One might (incorrectly) envision thereby setting off a chain reaction, with each succeeding set of fusions triggered in turn by the reaction-product particles resulting from the preceding set of fusions. Were it feasible, this approach would save initial energy as only a relatively few of all the deuterons would need to be energized.

One problem with this proposal is that the fusion products are all of extremely high energy (millions, even tens of millions, of electron volts) and therefore very fast, too fast (it can be shown mathematically) to have a high collision probability: the fusion reaction products simply pass through the remaining deuterium without creating further fusions.

Physicists describe this collision probability with the aid of what they call "cross sections," which can be thought of as resembling circular targets: the larger the target the more likely the collision. It can be shown mathematically that as the trigger particle's energy decreases the cross section (probability of collision) increases. Numerical calculations show that the most desirable range of cross sections correspond to energies below the coulomb barrier peak energy.

There is, therefore, a tradeoff: at lower energies the probability of penetrating the barrier is lower, but the cross section (collision probability) is higher. Numerical calculations indicate that, for deuterium absorbed in palladium, an energy range from about ten thousand electron

**PROPRIETARY DATA**  
**For Evaluation Purposes Only**

volts to three hundred thousand electron volts gives the greatest probability of fusion between pairs of deuterons.

Palladium offers several potential benefits for triggered fusion. First, deuterium easily diffuses through palladium which can be saturated with deuterons in a one to one ratio with the palladium crystal atoms. Second, the palladium nuclei are surrounded by relatively dense clouds of electrons: 46 electrons for each palladium atom, most bound but a few free. The effect of the electron clouds is rapidly to decelerate the passage of any charged particle, thereby resolving the problem of reducing the triggered-fusion product-particle energies. Palladium also possesses certain other desirable properties, such as a high melting point and good electrical conductivity.

The theory from which was derived the concept of triggered-fusion hypothesizes that palladium also exhibits electron screening of the Coulomb barrier potential to a greater degree than other metals. By electron screening is meant the effective interposition of electrons between positively-charged nuclei within the palladium crystal: either between the palladium nuclei and absorbed deuterons or between pairs of absorbed deuterons. Although the electrons move very fast, on the average an electron may be considered to be located between two positive nuclei, reducing the mutual electrostatic repulsion of the latter.

Strong screening effectively reduces both the "tail" and the "peak" of the barrier potential. Mathematically, strong screening would account for the high, so-called, mean-free-path of deuterons in palladium, explaining the relative ease of diffusion of deuterium through palladium. The existence of strong screening is amenable to proof by scattering experiment: large angular-deviations from classical or "Rayleigh" scattering are indicative of strong screening.

Imagine now a single high-energy deuteron incident upon a palladium crystal saturated with deuterons. The incident particle will lose energy in a mathematically predictable fashion as it passes through the electron clouds surrounding the palladium crystal nuclei. From time to time it will bounce off a palladium nucleus in an elastic (energy-conserving) collision. These collisions are of practical importance for without them the incident particle would fly straight through a thin target. With them more than half the incident particles will be brought essentially to rest, at most only a few millimeters from the crystal surface. However, some of them will collide and fuse with an absorbed deuteron. The probability of such fusions is mathematically calculable.

Occasionally, and more rarely, there will be a chain of successive fusions. But the mathematically-calculable probability of the length of such chains rapidly decreases between successive fusions, such that it would be extremely rare for there to be more than four or five total fusions in a particular chain. Of course the total number of fusions can be increased without limit simply by increasing the number of initial triggering particles.

Assuming an initial deuteron trigger, there are four possible successive fusion chains. But closer inspection will indicate there really are only two different ones, following the initial fusion event. Furthermore, as neutron reactions are highly improbable, only the single chain of alternating fusions of protons and helium-three particles with absorbed deuterons is likely.

Triggered-fusion might explain cold fusion observations. The likely triggered-fusion chain reaction shown above could also be triggered by high-energy protons, as is readily apparent from the chain. Such particles are the principal component of cosmic rays and of solar winds, and are also emitted by sun spots and solar storms. Such protons might trigger cold fusion, and would account for its random or stochastic non-reproducible behavior. But the incident-particle flux would have to be considerably higher than has been conventionally observed.

**PROPRIETARY DATA**  
**For Evaluation Purposes Only**

Whether or not protons emitted by solar flares or other sources in the cosmos actually trigger "cold" fusions, such triggered-fusion offers the first practical way to use fusion energy for the generation of electricity. Theory shows that the energy released by the average number of chain-reaction fusions generated by a single initial 300,000 electron-volt deuteron trigger will total almost ten times the energy of the trigger particle.

Because of mechanical and electrical losses, the actual amount of useful electricity generated by a continuing, large, number of such triggers would be less than ten times the total triggering energy; but a two or three to one ratio of output to input energy should be attainable. And since the needed input could be "fed back" from the generated output, a separate source of input power would only be needed initially to start a triggered-fusion generator.

A triggered-fusion electric power generator-cell could be designed in many ways, but all have certain aspects in common: (1) a beam of triggering deuterons, accelerated to about 300,000 electron volts (by, say, either a Cockcroft-Walton or van de Graff electrostatic generator for demonstration or start-up purposes, or by transformer feedback from the overall generator output in an operating electric power-generator); (2) a hollow palladium tube, bombarded by the deuteron trigger beam on one (out)side and containing heavy water on the other (in)side which provides the deuteron targets absorbed by the palladium as well as carries away the generated heat to an external heat-exchanger; (3) a (central) charging electrode (wire) held at a few volts to induce the deuterons from the heavy water to diffuse into the palladium tube.

An operating triggered-fusion electric power generator would contain, possibly, thousands of the individual cells described above, hundreds of which would be attached to or compose a single palladium pipe section. An external containment shield would protect against chemical explosion or emission of neutrons possibly generated by the triggered-fusion reactions. The external heat exchanger would be attached to a conventional, say, turbo-electric power generator. More unconventional generators, such as solid-state thermoelectric converters might be used in place of the heat exchanger/turbo-electric generator set, were comparable efficiencies attainable.

The necessary first step toward the practical application of triggered-fusion is the experimental proof of the underlying mathematical theory. Does a triggered-fusion cell actually produce more energy than it consumes, as predicted by that theory? This is the key question; if the answer is "yes," other experiments could then address the assumption of enhanced screening in palladium and concomitant phenomena, such as scattering cross section and Coulomb-barrier transmissivity. Inventors would then address such questions as the necessary diffusion rates of deuterons in palladium and other practical matters. But should the basic calorimetric experiment be successful, these latter issues probably can all be satisfactorily resolved and a practical triggered-fusion electric power generator developed. If so, we shall have witnessed the beginning of the end of the age of fossil fuels.



*George Curtis Sponsler*

ATTORNEY AT LAW

7604 OLD CHESTER ROAD, BETHESDA, MARYLAND 20817  
TELEPHONE 301/320-3431

April 6, 1993

Reed Jensen  
Associate Director  
Los Alamos National Laboratory  
Mailstop B-243  
Los Alamos, NM 87545

Dear Dr. Jensen,

Ed Storms suggested I contact you to inquire if Los Alamos might undertake an experimental test of a triggered-fusion theory of mine on which I have been working intermittently the past several years. Whether or not the theory explains so-called "cold" fusion, for which it was originally intended, if correct it would make possible the practical generation of electricity from deuterium (or proton) triggered fusion in deuterium-saturated palladium. Gerry Hale there at Los Alamos is currently reviewing the theory.

I envision an arrangement in which my company, Law Mathematics & Technology Inc., would serve as subcontractor - or I personally as consultant - to Los Alamos in the conduct of the experiment. I would ask that I be included as a coauthor of any papers and coinventor of any resulting patents. I would also ask that Los Alamos either pay me a sufficient amount to cover costs of foreign patents needed to extend coverage of a U.S. patent application I currently have pending (which latter also requires amendment) or prepare the necessary applications for me as payment in kind. I would require reimbursement for my consulting expenses, but would be willing to waive any additional fee beyond the patent arrangement as my financial contribution, if that were necessary.

Reed Jensen,  
April 6, 1993,  
page 2.

Walt Polansky of DOE headquarters once offered to match any Los Alamos contribution in support of such an experiment, which would test both the theory and its electric-generator application.

Enclosed are the latest versions of two papers explaining my theory and its power generation application. I would ask that, in accord with the legend on each page, you please use the papers for evaluation purposes only. I hope to discuss this proposal with you personally by telephone in the near future.

Sincerely,



George C. Sponsler

cc: W. Polansky  
E. Storms

enc.

New Energy Times

PROPRIETARY DATA  
For Evaluation Purposes Only

TRIGGERED-FUSION POWER GENERATOR

George C. Sponsler

To illustrate how triggered "cold" fusion could be employed to produce electrical power, one possible conceptual design is presented in the accompanying figure. Other triggered-fusion power generator configurations are conceivable, but they all incorporate certain common features, illustrated by the figure, which are discussed hereafter. Whether or not the proposed triggering mechanism explains experimentally-observed cold fusion, the triggered-fusion process itself appears to offer a practical means for generation of electrical power.

---

Place figure about here.

---

The figure portrays a single cell, there being perhaps hundreds or thousands of such cells in a large triggered-fusion electric power generator. (If a single cell generated a kilowatt, a megawatt generator would incorporate 1000 such cells).

Each cell consists of an ion gun which directs a stream of, say, 300 keV deuterons through an evacuated tube against the exterior of a thin palladium pipe target through which circulates a stream of heavy-water ( $D_2O$ ). Several ion guns could be mounted around a particular circumference of a long Pd pipe, with other circumferential mountings above and below. A single pipe might contain hundreds of such cells, and the entire triggered-fusion generator might consist of tens or hundreds of such pipes with their attached ion guns. The actual number of ion guns would be determined by the maximum power desired divided by the power generated per ion gun.

The heavy-water provides a steadily replaced supply of deuterons which are attracted to the palladium tube by an electric field created by a centrally-mounted low-voltage charged wire. The deuterons diffuse through the palladium tube and become targets for the triggering ions. The circulating heavy-water also conducts the fusion-generated heat to a heat exchanger, which then provides the heat energy for a conventional electric generator external to a neutron-reflecting shield surrounding and containing the entire assembly of triggered-fusion cells and Pd pipes.

This containment shield would also protect against the possibility of chemical explosion (possibly resulting from the accidental recombination of deuterium and oxygen, generated by the electrolytic decomposition of the heavy-water).

Van de Graff generators might be used to produce the 300 kilovolt electrostatic field required by the ion guns, provided the van de Graff machines could sustain the necessary current drain. Neglecting losses, the triggering theory<sup>1</sup> shows that each cell in effect amplifies its input power by a factor of about ten (each 300

---

<sup>1</sup> Sponsler, G.C., *Triggering "Cold" Fusion*, p. 14.

PROPRIETARY DATA  
For Evaluation Purposes Only

kev trigger particle produces on average 2.6 mev of total fusion energy, assumed to be converted to heat, to which must be added the 300 kev of heat energy generated by the trigger particle itself upon collision within the Pd pipe). Thus a one kilowatt cell, neglecting losses, would be triggered by about a 100 watt ion beam which at 300 kev corresponds to an ion-gun current of one-third milliamp.

It is assumed that the energy needed to power the ion guns would be fed back from the total power generated. The generated power level would in turn be controlled by the ion current. As noted above, much of the ion gun input power would be recaptured in the form of heat upon collision of the beam with the palladium pipe.

Provision would be needed to prevent the escape of, and where necessary to recapture, any deuterons which diffuse completely through the Pd pipe wall. Prevention might be accomplished by a thin coating, on the exterior of the Pd pipes outside the ion beam impingement area, of some metal which inhibits deuteron penetration. Any captured deuterium would be recombined with electrolyzed oxygen to recreate more heavy water (thereby also gaining a small additional increment of heat energy).

The thin-wall palladium pipe is the key to the operation of the triggered-fusion power generator. Physically it separates the heavy water - the coolant fluid and target-deuteron source - from the high-voltage deuteron ion gun beam, while simultaneously facilitating diffusion of the heavy-water deuterons to the outer pipe wall ion-beam impingement area. The palladium also conducts the generated heat away from this outer wall target area to the interior coolant heavy-water. The palladium electrons, which attenuate the energy of both incident and fusion-generated particles, prevent the possibility of a runaway chain reaction. More controversially, the enhanced electron-screening postulated for the palladium catalyzes the fusion reaction by enhancing the quantum mechanical transmissivity (Coulomb barrier penetration probability)<sup>2</sup>, and also produces a greater collision cross section<sup>3</sup> than is found experimentally with gaseous or liquid  $D_2O$ .<sup>4</sup>

Triggered-fusion would thus appear to offer a practical source of electrical power generation, whether or not it also explains experimentally observed "cold" fusion.

---

<sup>2</sup> Id., eqn. (19).

<sup>3</sup> Id. eqn. (12).

<sup>4</sup> Note: the screening radius,  $r_s$ , may be and probably is different for the deuteron/palladium collision cross section, which controls the mean free path of the diffused deuterons within the palladium, than for deuteron/deuteron collisions which affects their fusion probability within the palladium.

# Heavy-Water from Heat Exchanger

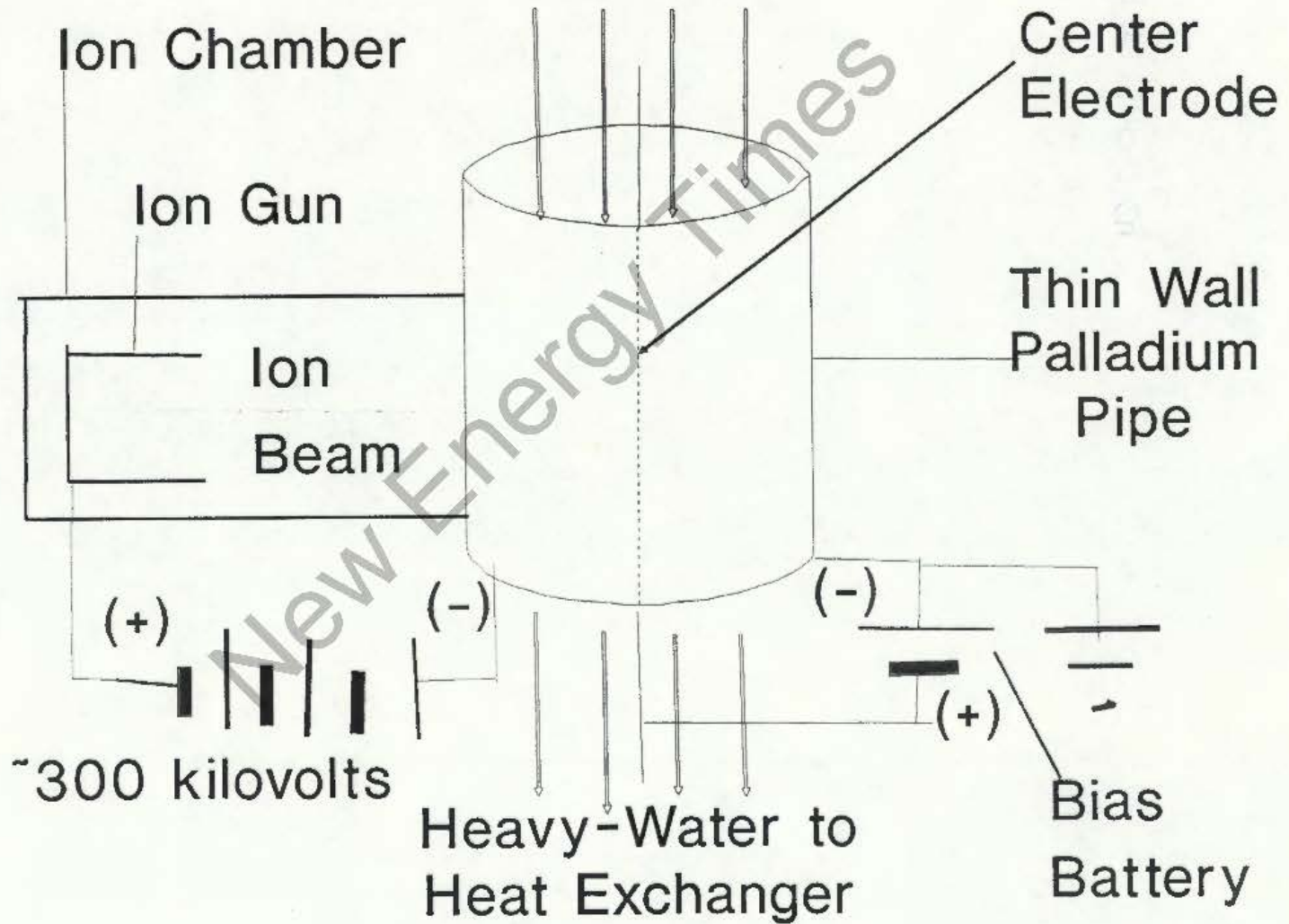

Preproposal ?

PROPRIETARY DATA  
For Evaluation Purposes Only

TRIGGERING "COLD" FUSION

by

George C. Sponsler<sup>1</sup>

Abstract

Theory demonstrates that "cold" fusion may be conventional hot fusion initiated by, and sustained by repeated, exogenous triggering. Once so triggered, fusion chain reactions of limited duration may also be possible in deuterium-saturated palladium. A single deuteron's energy is analyzed as it is attenuated by collisions with bound and free electrons in such a palladium crystal, and the associated cumulative fusion probability estimated. Probabilities of subsequent chain-reaction fusion events are also derived.

I. Introduction

The thesis of this paper is that what has been called cold fusion is really hot fusion in disguise. For this reason the word "cold" in the title above is put in quotes. It is suggested that the initiation of "cold" fusion requires a trigger, either natural or artificial (the subject of a separate patent application), externally impingent upon a palladium or similar metal matrix saturated with deuterium. Such a trigger might be a single (or shower of) high-energy cosmic ray(s), solar-wind or sun-spot particle(s), radiation from local radioactive contaminants, or some other energy source, which fuses with or energizes a deuteron within the palladium that, in the latter event, thereafter fuses with yet another deuteron.

There have been a number of experiments which claim to have demonstrated cold fusion; a review article by Storms<sup>1</sup> lists 76 "negative results" and 83 "positive results" by electrochemical experimenters. The principal problem with these reports is that they cannot be reproduced. At best, these experiments demonstrate that cold fusion, if it exists, must be a stochastic, that is chance or random, process.

The key problem for conventional cold fusion theory is to explain how it is possible for two thermal deuterons to overcome (or quantum-mechanically to tunnel through) their mutual electrostatic Coulomb potential barrier, and thus come close enough to fuse. Leggett & Baym<sup>2</sup> have shown that, in a solid in equilibrium at room temperature, Coulomb barrier penetration cannot be sufficiently enhanced to explain cold fusion rates inferred from experiments by others<sup>3</sup>. It is the apparent impossibility of such

---

<sup>1</sup> President, Law Mathematics and Technology Incorporated,  
7804 Old Chester Road, Bethesda, Maryland, 20817-6280.

PROPRIETARY DATA  
For Evaluation Purposes Only

barrier penetration which has persuaded the majority of the scientific community - familiar as they are with high-temperature compressive fusion inside stars and hydrogen bombs - to reject the very idea of cold fusion.

Apparently the first cold fusion theory was that of Paneth and Peters, published in October 1926<sup>4</sup>, who also attempted to demonstrate experimentally the conversion of hydrogen into helium, using palladium as a catalyst. But their initial seeming success was subsequently reversed when they discovered the observed helium most probably had actually been a contaminant in their experiment.

John Tandberg, working in Stockholm and influenced by the reports of Paneth and Peters, built an electrolytic cell using a palladium electrode in an attempt to separate hydrogen from oxygen in ordinary water.<sup>5</sup> Tandberg, in collaboration with Torsten Wilner, later repeated his electrolysis experiment using heavy water. And in the 1940s Tandberg and Wilner bombarded a deuterium-saturated palladium metal sheet with deuterons - recording the generation of <sup>3</sup>He and neutrons. They may thus have inadvertently triggered a deuterium fusion reaction.<sup>6</sup>

Most recently, Brookhaven chemists claim also to have induced such fusion by bombarding a deuterium target (composed of titanium or zirconium deuteride, or of polydeuteroethylene) with heavy water clusters containing from 25 to 1300 molecules, using beam energies of between 200 kev and 325 kev.<sup>7</sup> They theorized that the heat and compression generated by the impact cause pairs of deuterium atoms to fuse, momentarily creating <sup>4</sup>He and releasing the binding energy. The helium was then thought to disintegrate spontaneously along either of the two more common fusion branches (c.f. Table 1 below).

The presently known hydrogen-isotope fusion reactions are listed in Table 1<sup>8</sup>. The reaction byproducts reported by Tandberg and Wilner correspond to the first so-called branch, with an energy release of 3.27 mev per reaction. (Note:  $1.9 \times 10^{12}$  of these

*Table 1: Known Deuterium Fusion Reactions  
with Hydrogen Isotopes*

<u>PRIMARY REACTION</u>	<u>BRANCH PRODUCTS</u>	<u>ENERGY (E<sub>r</sub>) RELEASE (MeV)</u>	<u>REACTIONS/SEC PER 1W OUTPUT</u>
D + D →	<sup>3</sup> He + n	3.27	$1.90 \times 10^{12}$
D + D →	T + p	4.03	$1.54 \times 10^{12}$
D + D →	<sup>4</sup> He + gamma	23.85	$2.61 \times 10^{11}$
T + D →	<sup>4</sup> He + n	17.59	$3.53 \times 10^{11}$
p + D →	<sup>3</sup> He + gamma	5.49	$1.13 \times 10^{12}$

reactions would be needed every second to produce only one watt of

PROPRIETARY DATA  
For Evaluation Purposes Only

power!). A sixth reaction,  $T + p$ , is often added to Table 1, but this reaction may only be intermediary between the reactions on rows 2 and 3, above, as indicated by the sum of the released binding energies of  $D + D \rightarrow T + p$  (4.03 mev) and  $T + p \rightarrow {}^4\text{He} + \text{gamma}$  (19.81 mev) compared with line 3's (23.85 mev) of Table 1.

Cold-fusion enthusiasts have proposed other, more exotic and not as yet accepted, deuterium fusion reactions within palladium which are not included in Table 1. For example, Akito Takahashi, a professor of nuclear engineering at Osaka University in Japan, has suggested a four-body nuclear reaction that produces no neutrons; and Peter Hagelstein of MIT asserts that while neutrons are emitted in cold-fusion reactions they are promptly absorbed by the palladium lattice.<sup>9</sup>

The theory hereafter is restricted to the accepted deuterium reactions of Table 1, with subsequent consideration of neutron-initiated and  $D+{}^3\text{He}$  reactions.

## II. Theory

Consider a single cubic cell of a pure, face-centered palladium crystal saturated with deuterium. The crystal lattice constant or cell-width is almost exactly  $4 \times 10^{-8}$  cm in length. There is one palladium atom at each corner, and there are assumed to be  $f$  "free" electrons and  $(46 - f)$  "bound" electrons, these latter uniformly distributed within a sphere of radius  $r$  centered on each palladium nucleus. The probability,  $P_{pd}$ , that a particle incident on a cell penetrates one of the bound electrons' eight segments within the cell (and hence of any and all cells) is given by  $(4/3)\pi(r/a)^3$ ; while the probability,  $P_f$ , that the particle passes through the intervening free electrons is given by  $(1 - P_{pd})$ .

Imagine the path of the incident particle (hereafter taken to be a deuteron) to be a series of random, broken line-segments (rather like Brownian-motion, or the ricochets in a pin-ball machine), making elastic collisions with the palladium crystal atoms' nuclei and with a total path length  $x$ . The incident particle will lose energy through successive collisions with both bound and free electrons, the differential amount,  $dE/dx$ , being given by:

$$\frac{dE}{dx} = P_{pd} \left. \frac{dE}{dx} \right|_b + P_f \left. \frac{dE}{dx} \right|_f \quad (1)$$

where the subscripts  $b$  and  $f$  refer to "bound" and "free" respectively.

Jackson<sup>10</sup> derives the various differential energy loss formulae needed to evaluate (1). Quantum mechanics is only required in the derivation of the Bethe formula<sup>11</sup> for the energy loss at high (1 mev and greater) incident particle energy,  $E$ :

$$\left. \frac{dE}{dx} \right|_b = \frac{92\pi\rho_{pd}Z^2e^4M_z}{mE} \ln \left[ \frac{4mE[\gamma(E)]^2}{M_z\hbar(\omega_b)} - \frac{2E}{M_zC^2} \right], \quad E \geq 1 \text{ mev} \quad (2)$$



PROPRIETARY DATA  
For Evaluation Purposes Only

where  $\rho_{Pd}$  is the concentration of palladium crystal atoms per cc;  $Z$  &  $M_z$  are the atomic number and mass of the incident particle (in the first instance, deuterium);  $e$  &  $m$  are the electron charge and mass;  $\gamma(E) = [1+(E/M_z c^2)]$  is a relativistic correction term; and  $\omega_b$  is an average palladium-atom bound electron frequency (taken to be 552 ev or  $8.83 \times 10^{-10}$  ergs, per Jackson's example<sup>12</sup>).

A classical, differential energy-loss formula is employed (with correspondingly different electron concentrations) for both bound and free electron collision losses at incident particle energies,  $E$ , less than 1 mev, and also (for computational convenience) as an approximation for (the smaller) free-electron collision losses at higher energies. (As will be shown, this latter use is permitted not only because incident-particle energy attenuation is much greater by bound electrons than free electrons, but the cumulative probability of collision and fusion of an incident high-energy deuteron with an occluded thermal deuteron typically is less than 2% at energies greater than the peak deuteron barrier potential assumed hereafter to be about 327 kev inside the palladium matrix).

This classical formula is derived from an expression yielding the energy transferred to a free electron during a Coulomb collision, as a function of the so-called impact parameter (or closest approach),  $b$ , given by<sup>13</sup>:

$$\Delta E(b) = \frac{Z^2 e^4 M_z}{mE} \cdot \frac{1}{\left[ b^2 + \left( \frac{M_z Z e^2}{2mE} \right)^2 \right]} \quad (3)$$

where  $Z$  refers to the incident particle.

The desired formula for the free-electron differential energy loss is obtained by integrating (3) from 0 to  $b_{max}$ , as follows<sup>14</sup>:

$$\left. \frac{dE}{dx} \right|_f = 2\pi \rho_e \int_0^{b_{max}} \Delta E(b) b db \quad (4)$$

where  $\rho_e$  is the electron concentration (with  $e = b$  or  $f$ , for bound or free electrons, respectively); and  $b_{max}$  is given by<sup>15</sup>:

$$b_{max}(E) = \frac{\gamma(E)}{\omega} \sqrt{\frac{2E}{M_z}} \quad (5)$$

where  $\omega$  is a characteristic atomic frequency of motion, in numerical calculations chosen so as to match the Bethe and free

PROPRIETARY DATA  
For Evaluation Purposes Only

electron formulae (with  $e = b$ ) at  $E = 1$  mev (which yields a value of about 1.4 kev for  $\hbar\omega$ ).

Equation (4) is integrable in closed form, yielding:

$$\frac{dE}{dx}_e = \frac{\pi\rho_e e^4 M_z Z^2}{mE} \ln \left[ 1 + \left( \frac{2b_{\max}(E) mE}{ZM_z e^2} \right)^2 \right] \quad (6)$$

where subscript  $e$  is either  $f$  (for free) or  $b$  (for bound), as before, and  $\rho_f = f\rho_{Pd}$  or  $\rho_b = (46-f)\rho_{Pd}$  (with the formulae  $f$  being the number of free electrons). This formula is used in the subsequent calculations for bound electrons when  $E \leq 1$  mev, and for free electrons for all  $E$ .

To appreciate how rapidly the incident-particle energy attenuates along the path length of the incident particle within the deuterium-saturated palladium crystal, it is only necessary to integrate eqn. (1):

$$x(E) = \int_E^{E_t} \frac{1}{\left[ P_{Pd} \frac{dE}{dx}_b + P_f \frac{dE}{dx}_f \right]} dE \quad (7)$$

Here  $x(E)$  is the total distance along the (discontinuous) path followed by an incident particle of initial (or "trigger") energy,  $E_t$ , to the point where the particle energy has attenuated to  $E$ . The differential energy losses,  $dE/dx|_b$  and  $dE/dx|_f$ , are given by (2) and (6) above for the various energy ranges noted before.

With the aid of a numerical personal computer program<sup>16</sup>, the graphs of figures (1) and (2) were computed for the energy ranges shown (in ergs) for a hypothetical initial or trigger particle-energy of 3 mev. Both graphs show, for example, that that energy will have been attenuated to about 300 kev after traversing a total distance of about 0.05 cm. from the particle's initial point of entry into the palladium crystal (employing the various parametric values previously noted). Assuming that "cold" fusion is initiated by an exogenous trigger, it is apparent from these calculations that such fusion must be ignited close to the surface of the deuterium-saturated palladium target or electrode.

---

Put figures (1) & (2) about here.

---

The more important question, however, is: What is the cumulative probability of fusion of an initial or trigger deuteron with one or another of the thermal deuterons occluded in the palladium? This question is answered indirectly by first asking what is the D/D collision probability as a function of the incident

PROPRIETARY DATA  
For Evaluation Purposes Only

particle's attenuating energy, and then multiplying that collision probability,  $R(E)$ , by the (potential-barrier) transmission probability,  $T(E)$ , to yield the fusion probability density function,  $P_f(E)$ . This latter function is then integrated over the entire range of energies below the trigger-energy to determine the desired cumulative probability of fusion.

Let  $Q$  be the probability that an incident particle does NOT make a collision in the path length  $x$ . Between  $x$  and  $(x+dx)$ ,  $Q$  is decreased by an amount equal to the probability that a collision does occur within that incremental distance. But this amount is equal to the probability that the particle reaches the point  $x$  without collision, times the probability that if it is in this region a collision does occur. This latter probability is simply  $\rho_D \sigma dx$ , so that<sup>17</sup>  $dQ = -Q \rho_D \sigma dx$  where  $\rho_D$  is the deuterium concentration. Since  $dQ/dx = (dQ/dE)(dE/dx)$ , when expressed as a function of  $E$ ,  $dQ = -[Q \rho_D \sigma(E)]/[dE/dx]dE$ . Integration then yields:

$$Q(E) = \exp \left[ \rho_D \int_{E_c}^E \frac{\sigma(E)}{\left[ P_{pd} \frac{dE}{dx} \Big|_p + P_f \frac{dE}{dx} \Big|_f \right]} dE \right] \quad (8)$$

where (1) above has been substituted for  $dE/dx$ , which in turn has been recognized as intrinsically negative, being an attenuation.

The cumulative probability,  $R(E)$ , that an incident particle DOES make a collision by the point at which its energy has attenuated to  $E$  is then given by  $R(E) = 1 - Q(E)$ , with  $Q$  expressed as a function of  $E$  rather than  $x$ .

To evaluate the integral in (8) it is first necessary to determine  $\sigma(E)$ . Following Bohm<sup>18</sup>, the D/D scattering cross section per unit solid angle for a screened Coulomb potential is given by:

$$\sigma_\theta = \frac{4M_D^2 e^4}{(4p^2 \sin^2 \theta / 2 + \hbar^2 / r_s^2)^2} \quad (9)$$

in which  $M_D$  is the mass of the deuteron,  $\theta$  is the scattering angle,  $\hbar$  is Planck's constant divided by  $2\pi$ ,  $p = (2mE)^{1/2}$  is the incident deuteron's momentum expressed in terms of its kinetic energy,  $E$ , and  $r_s$  is the effective screening radius (taken here to be  $4 \times 10^{-12}$  cm, corresponding to a maximum deuteron barrier potential of 327 kev at the edge of the nuclear well, according to the screened Coulomb formula of equation 17 below).

The total D/D collision cross section,  $\sigma(E)$ , is obtained from (9) by integrating over the entire solid angle, as follows:

PROPRIETARY DATA  
For Evaluation Purposes Only

$$\sigma(E) = \int_0^{\frac{\pi}{2}} \frac{16\pi M_D^2 e^4 \sin\theta d\theta}{(8M_D E \sin^2\theta/2 + \hbar^2/r_s^2)^2} \quad (10)$$

Equation (10) is integrable in closed form<sup>2</sup> using the following formula:

$$\int \frac{a \sin\phi}{[b \sin^2 \frac{\phi}{2} + c]^2} d\phi = \frac{2a}{b[b \cos^2 \frac{\phi}{2} - b - c]} \quad (11)$$

which may be proved by direct differentiation. Insertion of the integration limits of (10) and simplification yields:

$$\sigma(E) = \frac{\alpha}{\mu \left[ \mu + \frac{\beta(E)}{2} \right]} \quad (12)$$

where  $\alpha = 16\pi M_D^2 e^4$ ,  $\beta(E) = 8M_D E$ , and  $\mu = (\hbar/r_s)^2$ . Using this closed expression for  $\sigma(E)$  it is then easy to evaluate  $Q(E)$ , and from it  $R(E)$ , by numerical integration of (8).

$\sigma(E)$  as given by (12) is the effective D/D cross section inside the palladium matrix, where it has been assumed that  $r_s = 4 \times 10^{-12}$  cm in order that the screened Coulomb potential at the edge of the nuclear well be 327 kev. To the extent this assumed screening radius is correct, it represents enhanced screening caused by the palladium matrix. Even with this screening radius, according to (12),  $\sigma(E \approx 300 \text{ kev}) \sim 70$  barns (c.f. figure 3), or about 100 times the experimental D/D cross section of approximately 100 mb in the gaseous state<sup>19</sup>. The cross section would be larger in any metal, but the effect of enhanced screening in Pd reduces the maximum value of the deuteron Coulomb potential barrier and increases the transmissivity,  $T(E)$ . The net effect of enhanced Pd screening would be to increase the probability of D/D fusion. **PUT FIG. 3 ABOUT HERE.**

Equation (12) also explains why deuterium (and hydrogen) diffuse more easily within palladium than in other metals. If the screening in palladium is substantially greater than within other metals, for the same energy, according to (12), the cross section should be reduced for smaller  $r_s$ , that is for increased screening (whether it be D/D or D/Pd). The correspondingly smaller cross section in the palladium would reflect itself in a greater mean free

<sup>2</sup> With thanks to Bob Gautier of Mathsoft Inc. for his original recognition thereof.

PROPRIETARY DATA  
For Evaluation Purposes Only

path, which in turn would help explain the increased ease of diffusion of deuterium (and hydrogen) inside the palladium matrix.

Figures (4) and (5) show the cumulative probability of collision,  $R(E)$ , between trigger deuterons of energies 3.27 mev and 327 kev, respectively, and a thermal deuteron occluded in a deuterium-saturated palladium matrix. Fig. (3) demonstrates that, during the interval that the incident deuteron energy has attenuated from 3.27 mev to 327 kev, the cumulative probability of collision is less than 2%. Whereas fig. (4) shows that almost all the cumulative collision probability accrues in the interval between 327 kev and 16 kev; this is the critical attenuated energy regime. It is energetically wasteful, and almost useless, to employ deuteron trigger energies greater than 300 to 400 kev to initiate a D/D fusion reaction inside the palladium.

---

Put figures (4) & (5) about here.

---

The probability density distribution that an incident deuteron collides with another (thermal) deuteron in the interval between  $E$  and  $E+dE$  is obtained by differentiating the cumulative distribution,  $R(E)$ , and hence is given by the negative derivative of  $Q(E)$ . If  $T(E)$  is the transmission probability that the incident particle penetrates the potential barrier of a thermal deuteron, then the cumulative probability of fusion,  $P_f(E)$ , in the interval between the initial trigger energy,  $E_t$ , and the attenuated energy,  $E$ , is given by:

$$P_f(E) = \int_{E_t}^E T(E) dR(E) = - \int_{E_t}^E T(E) \left[ \frac{dQ(E)}{dE} \right] dE \quad (13)$$

For incident-particle energies greater than the maximum deuteron Coulomb barrier potential (about 327 kev), the transmission probability,  $T(E > 327 \text{ kev})$ , is unity. In this regime the cumulative probability of fusion, as  $Q(E_t) = 1$ , is given by:

$$P(E > 327) = - \int_{E_t}^{E > 327} dQ = [1 - Q(E > 327)] \quad (14)$$

Note that for  $E_t = 3.27 \text{ mev}$ ,  $P(E = 327 \text{ kev}) = 0.018$  for D/D fusion, and is approximately the same value for other triggers of comparable energies.

For trigger energies less than 327 kev it is necessary to employ the full formula of eqn. (13), which in turn requires evaluation of the derivative with respect to  $E$  of  $Q$  given by:

PROPRIETARY DATA  
For Evaluation Purposes Only

$$\frac{dQ}{dE} = \frac{\rho_D \sigma(E) Q(E)}{\left[ P_{Pd} \frac{dE}{dx} \Big|_b + P_f \frac{dE}{dx} \Big|_f \right]} \quad (15)$$

The WKB approximation for the transmission probability,  $T(E)$ , of one deuteron penetrating a second deuteron by quantum mechanical tunneling through a screened Coulomb barrier potential,  $V_D(r)$ , is given by<sup>20</sup>:

$$T_s = \exp \left[ -\frac{2}{\hbar} \int_{r_0}^{r_1} \sqrt{2M_D(V_D - E)} dr \right] \quad (16)$$

where the radius of the deuteron nucleus is approximated by  $r_0 = 4 \times 10^{-13}$  cm, and  $r_1$  is that (radial) distance at which the potential,  $V_D$ , equals the relative energy,  $E$ , of the two deuterons, (taken to be the kinetic energy of the incident deuteron), i.e.

$$E = [e^2/r_1] \cdot \exp(-r_1/r_s),$$

assuming the screened potential is given by the Fermi-Thomas model:

$$V_D = \frac{e^2}{r} \exp(-r/r_s) \quad (17)$$

In point of fact (17) represents the electrostatic field experienced by a positive, singly-charged test particle resulting from another unit positive charge located at the coordinate origin and an equal negative charge distributed about it with density  $\rho$  (the system as a whole being electrically neutral) given by<sup>21</sup>:

$$\rho = -\frac{a^2}{4\pi} \frac{e^{-ar}}{r} \quad (18)$$

where  $a = 1/r_s$ , i.e. the reciprocal of the screening radius.

This is a rather unlikely charge distribution for the electron cloud surrounding an atomic nucleus: it does not allow for a charge-free space between the atomic nucleus and the innermost electron orbit; it represents an unbounded orbital electron charge distribution extending outward from the center of the nucleus to infinity; and there is no a priori physical reason for the negative exponential factor, (except the experimental fact that the actual field diminishes rapidly).

PROPRIETARY DATA  
For Evaluation Purposes Only

Although the Fermi-Thomas approximation will be used hereafter, it is interesting to derive the exact formula for the electrostatic potential generated by an arbitrary (but spherically symmetric) electron charge distribution. Such a formula is derived in Appendix 1, where it is presented for the record as Eqn. (2A).

Employing the Fermi-Thomas model, the WKB transmission probability is easily calculable by numerical integration (via personal computer), with results as presented in Figure (6) for various incident deuteron energies in the critical range between 16 kev and 327 kev. We observe that the transmission probability is essentially zero for smaller energies, which hereafter will therefore be neglected.

---

Put figure (6) about here.

---

If we take  $T(E > 327 \text{ kev}) = 1$ , then the cumulative fusion probability,  $P_f$ , for  $E_t = 3.27 \text{ mev}$  exactly, and for other  $E_t > 1 \text{ mev}$  approximately, is given by:

$$P_f = 0.018 - \int_{327 \text{ kev}}^{16 \text{ kev}} T(E) \left[ \frac{dQ}{dE} \right] dE = 0.356 \quad (19)$$

using the expressions for  $R(E)$ ,  $T(E)$ , and  $dQ/dE$  developed above.

The fact that the cumulative fusion probability equals 0.356 for almost any trigger deuteron of energy greater than about 327 kev, in combination with the fact apparent from Table 1 that all possible D/D fusions produce at least 3.27 mev, means that a 327 kev deuteron trigger on the average will yield an expected fusion energy of at least  $3.27 \times 0.356 = 1.16 \text{ mev}$ .

But on reflection it will be apparent that the cumulative fusion probability,  $P_f$ , is actually the probability that there will be one or more fusions in a chain initiated by an initial trigger, and there will therefore be a greater expected total energy yield.

The first fusion may produce a subsequent second fusion, and that in turn yet a third, and so on in a chain of possible subsequent fusions. Thus there is a small but finite probability of triggering a fusion chain reaction. Using a large number of triggers simultaneously would have a correspondingly greater chance of initiating multiple such chain reactions with correspondingly greater energy releases. More about these possibilities will be considered subsequently.

But first, one might be tempted to imagine that an initial (as well as a succeeding) trigger, if not successful in producing a fusion, might transfer by collision a significant fraction of its kinetic energy to another deuteron that in turn might then produce a fusion with yet another deuteron. But regrettably, the average energy transferred by collision without fusion is insignificant.





PROPRIETARY DATA  
For Evaluation Purposes Only

interacting with another deuteron, thus continuing the particular chain of fusion reactions.

Although these two chains both derive initially from the first nuclear reaction of Table 1, a little thought will demonstrate the same two chains will also develop from the second branch,  $D+D \rightarrow T+p$ . As is apparent from Table 2, significant energies are released by the alternating nuclear reactions of both pairs of chains.

*Table 2: Selected Deuterium Fusion Reactions*

<u>PRIMARY REACTION</u>	<u>BRANCH PRODUCTS</u>	<u>ENERGY (<math>E_r</math>) RELEASE (MeV)</u>
${}^3\text{He} + \text{D} \rightarrow$	${}^4\text{He} + \text{p}$	18.4
$\text{n} + \text{D} \rightarrow$	$\text{T} + \text{gamma}$	6.26
$\text{T} + \text{D} \rightarrow$	${}^4\text{He} + \text{n}$	17.59
$\text{p} + \text{D} \rightarrow$	${}^3\text{He} + \text{gamma}$	5.49

Of the two possible chains triggered by a  $D+D$  fusion reaction (yielding either the  ${}^3\text{He}+n$  or  $p+T$  branches, but both resulting in the same two chains of alternating secondary nuclear reactions, as noted previously), only that one involving the alternating  ${}^3\text{He}+D$  and  $p+D$  reactions would appear to be likely in deuterium-saturated palladium. The other chain involves neutron fusion reactions. Since the neutron cross section of palladium is some 10,000 times greater than that of deuterium (7 barns versus 0.5 millibarns, respectively<sup>24</sup>) any neutrons released are far more likely to be absorbed by the palladium nuclei than by the deuterons, corresponding to a comparably small probability that the second chain reaction would persist.

The question thus becomes, what are the probable lengths of the more likely alternating  ${}^3\text{He}+D$  and  $p+D$  fusion reaction chains?

To answer this question it becomes necessary to calculate the probability density distribution for the number of possible fusion events in both chains diagramed on page 11. Let  $P_f(n)$  be the probability that there are exactly  $n$  such fusions in one of the chains. And let us first consider the chain beginning with the branch  $d+d \rightarrow {}^3\text{He}+n$ .

Eqn. (19) gives the cumulative probability of a  $d+d$  fusion event as 0.356; let us designate this probability as  $P_d$ . By substituting the proper values of mass,  $M_z$ , and potential,  $V_z$ , in the formulae leading to eqn. (19) (but assuming the same shielding radius,  $r_s$ , applies to all), it may be shown that the corresponding probabilities for  $p+D$  and  ${}^3\text{He}+D$  fusions are given, respectively, by  $P_p = 0.203$  and  $P_3 = 0.295$ .

PROPRIETARY DATA  
For Evaluation Purposes Only

It should be noted in passing that all fusions are considered to involve at least one deuteron. The probabilities of fusion reactions not involving a deuteron are negligible, as the concentrations of other potential fusion partners are extremely small compared to the deuterium concentration within the palladium matrix. Even if one were to operate a "cold" fusion generator at a one megawatt power level (see discussion below), the concentration of deuterium atoms in the palladium would still be some ten thousand times greater than other possible fusion-generated byproduct elements, as attested by column four of Table 1.

Whereas the probability,  $P_d$ , of a D+D fusion is 0.356, the probability of a single such fusion with no subsequent chain reaction fusions is given by  $P_f(1) = P_d \cdot [1 - P_p]$ . Similarly, the probability that there are exactly two fusions in the chain is given by  $P_f(2) = P_d \cdot P_p \cdot [1 - P_p]$ . By mathematical induction it is easily proved that, in general:

$$\begin{aligned}
 P_f(n) &= P_d \cdot P_p^{\frac{n}{2}} \cdot P_p^{\frac{(n-2)}{2}} \cdot [1 - P_p], & n \text{ even} \\
 &= P_d \cdot P_p^{\frac{(n-1)}{2}} \cdot P_p^{\frac{(n-1)}{2}} \cdot [1 - P_p], & n \text{ odd}
 \end{aligned}
 \tag{22}$$

The average number,  $\bar{n}$ , of fusions in the chain initiated by a single deuteron trigger is given by:

$$\bar{n} = \sum_{n=1}^{\infty} n \cdot P_f(n)
 \tag{23}$$

This sum converges very rapidly, and only the first four or five terms are significant. Calculations show that, for the fusion chain initiated by the  $d+d = {}^3\text{He}+n$  branch:  $P_f(1) = 0.251$ ;  $P_f(2) = 0.084$ ;  $P_f(3) = 0.015$ ;  $P_f(4) = 0.005$ ; and  $P_f(5) = 0.0009$ . Figure 7 pictures these probabilities for the first six possible fusions in the chain. The corresponding expected number,  $\bar{n}$ , of fusions in the chain so initiated is 0.6.

---

Put figure (7) about here.

---

The average number of fusions to be expected when the chain is initiated by the  $d+d = T+p$  branch is calculated to be 0.365.

If we restrict ourselves to the  ${}^3\text{He}+n$  branch for the moment, the average energy of all the fusions in the chain triggered by a single deuteron is given by replacing  $n$  in the sum of eqn. (23) by

PROPRIETARY DATA  
For Evaluation Purposes Only

$E(n)$ , where  $E(1) = 3.27$  mev and  $E(n \text{ even}) = 18.4$  mev and  $E(n \text{ odd}) = 5.49$  mev thereafter, as diagramed on page 11. Evaluating the resulting sum, if we initiate the chain with a single 300 kev deuteron, we may expect to realize about 2.6 mev of energy, representing almost a 9-fold return on the initial trigger energy. This expected return would have to be reduced by generator efficiency, but the calculation demonstrates that triggered "cold" fusion should be capable of producing surplus power.

In principle, it should be possible to feedback part of the energy thus generated to permit continuing triggers. If there were an overall 25% power generation efficiency, it would still be possible to feedback 300 kev of energy per trigger deuteron and have a residual 300 kev of net generated energy per trigger remaining after feedback. The feedback loop could be controlled to permit a gradual and safe build-up of power to substantial amounts. Thus practical power generation with triggered "cold" fusion would appear to be mathematically possible with the various assumptions made heretofore.

### III. Conclusion

In summary, "cold" fusion is triggered hot fusion. Conventional cold fusion experimental results<sup>25</sup> are readily explicable on the assumption of exogenous triggering by cosmic rays (including solar-wind and sun-spot particles), adjacent radioactivity, or other external or superficial energy sources. Electrochemical experiments should be reviewed to identify possible triggers. The nonreproducibility of such experiments should then reflect the stochastic or chance nature of the particular triggering. For example, cosmic ray showers of extended duration and of different intensities could account for the variation in both duration and intensity of the resulting triggered "cold" fusion.

The function of the palladium in such experiments is three-fold: (1) its bound and free electrons attenuate the energy of the trigger and triggered particles (that is, both initial and fusion-generated) to the range where their corresponding collision cross section (enhanced over that of gaseous deuterium) becomes large enough to sustain fusion; (2) it facilitates the internal diffusion of deuterium; and, related but as yet unproved, (3) its enhanced electron-screening improves the Coulomb-barrier transmission or penetration probability.

Artificial triggering may permit the practical generation of significant amounts of power, employing feedback both to supply the required continuing triggering energy and to control the level of power generation. Perhaps as much as half the total power thus generated might be needed to continue the artificial triggering, but the other half would be available for practical use.

The foregoing theory, supporting the concept of triggered "cold" fusion, may be tested experimentally. If verified, it could introduce a new era in power generation.

PROPRIETARY DATA  
For Evaluation Purposes Only

Appendix I

ELECTROSTATIC POTENTIAL OF A SPHERICALLY-SYMMETRIC DISTRIBUTION  
OF NEGATIVE CHARGE SURROUNDING AN EQUAL POSITIVE POINT CHARGE

Imagine an atom to be represented by a point nucleus of positive charge,  $Ze$ , at the center of a spherical volume of equal and opposite (i.e. negative) total charge,  $-Ze$ , distributed continuously about the nucleus in a possibly layered but spherically-symmetric cloud of charge density,  $\rho(s)$ . The spherical electron cloud may or may not be hollow, with outer radius,  $s_2$ , and inner radius,  $s_1$ , (this latter possibly being zero).

The electrostatic potential of this idealized atomic model may easily be calculated by imagining the electron cloud to be composed of concentric spherical shells of differential thickness,  $ds$ , each of which contributes differentially to the total potential,  $V(r)$ , which may then be obtained by integrating over  $s$ .

Fig. 8 portrays one such spherical shell. We calculate the potential upon a unit positive charge situated a distance,  $r$ , from the nucleus of the atom. In so doing we must exercise care as to the algebraic sign of the potential: outside the shell the sign is positive, indicating the positive test charge would be attracted toward the center of the shell. But inside the sign must be negative, as the test positive charge would be attracted away from the center.

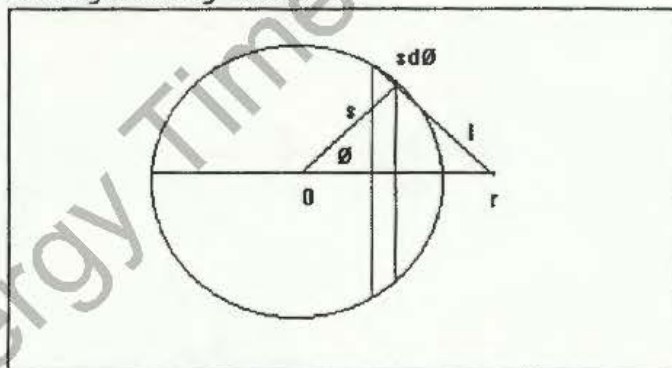

Fig. 8: Spherical Shell Geometry

As the net charge of the positive nucleus and of its surrounding equally charged but negative electron cloud is zero, we can foresee that the electrostatic potential outside the shell must also be zero, in accord with the integral form of the divergence theorem.

Inside a particular spherical shell the potential is twice the Coulomb potential of an equal positive charge alone located at the center of the shell. To prove this fact, consider a single spherical shell of charge  $-Ze$  centered on an equal positive charge located at the origin. As shown by Fig. 8, let  $r$  be the radial distance from the positive charge,  $Ze$ , located at the center of the spherical shell of radius  $s$ , whereon the charge density is given by  $\rho = -Ze/4\pi s^2$ . If we consider a narrow circular ring of charge on the shell (centered on the radius vector,  $r$ , drawn to a unit positive test charge) of width  $s \cdot d\phi$  and ring-radius  $s \cdot \sin\phi$  (where  $\phi$  is the angle between  $r$  and the shell radius connecting the ring with the positive charge at the origin), the potential seen by the unit positive charge inside the shell is given by:

PROPRIETARY DATA  
For Evaluation Purposes Only

$$V = Ze^2 \left\{ \frac{1}{r} + \frac{1}{2} \int_0^\pi \frac{\sin\phi d\phi}{\sqrt{r^2 + s^2 - 2rs\cos\phi}} \right\} \quad (1A)$$

If we substitute  $x = \cos\phi$  and simplify, it will be seen that the term containing the integral is precisely equal to  $1/r$ . Hence the electrostatic potential inside the spherical electron shell is indeed precisely twice the Coulomb field of the nucleus alone.

Outside the shell the sign of the integral term must be reversed. The integral is then equal to  $-1/r$ , and as predicted the net electrostatic potential everywhere outside, given by eqn. 1A, is zero.

Consider next that the electron shell of fig. 8 possesses a differential thickness,  $ds$ . If  $\rho(s)$  is the volumetric charge density of the spherical shell located a distance  $s$  from the center, then the differential charge of the shell is given by  $dq = 4\pi s^2 \rho(s) ds$ . The integral of this differential charge over the entire electron cloud is, of course,  $Ze$ , and its potential contribution follows the same sign convention as noted before. Thus we see that the potential experienced by a unit positive charge, distance  $r$  from the point nucleus, generated by the entire electron cloud, centered upon the nucleus of equal but opposite charge, is given by:

$$V(r) = \frac{Ze^2}{r} \left( 1 - 4\pi \left[ \int_{s_1}^r s^2 \rho(s) ds - \int_r^{s_2} s^2 \rho(s) ds \right] \right) \quad (2A)$$

in which  $\rho$  has been normalized by factoring-out the coefficient,  $Ze^2$ .

Eqn. 2A gives the electrostatic potential anywhere inside the outer limit,  $s_2$ , of the electron cloud surrounding a nucleus of equal but opposite charge,  $Ze$ . For  $r \geq s_2$  the potential is 0, corresponding to total electronic screening.

PROPRIETARY DATA  
For Evaluation Purposes Only

References

1. E. Storms, "Review of Experimental Observations about the Cold Fusion Effect," *Fusion Technology*, **20**, pp. 433-477, (1991).
2. A.J. Leggett & G. Baym, "Can Solid-State Effects Enhance the Cold-Fusion Rate?" *Nature*, **340**, pp. 45-46, 6 July 1989, and "Exact Upper Bound on Barrier Penetration Probabilities in Many-Body Systems: Application to "Cold Fusion," *Physical Review Letters*, **63**, No. 2, pp. 191-194, (10 July 1989).
3. M. Fleischmann, S. Pons, & M. Hawkins, "Electrochemically Induced Nuclear Fusion of Deuterium," *J. Electroanal. Chem.*, **261**, p. 301, 1989, and erratum, **263**, p. 187, 1989, and S.E. Jones, E.P. Palmer, J.B. Czirr, D.L. Decker, G.L. Jensen, J.M. Thorne, S.F. Taylor, & J. Rafelski, "Observation of Cold Nuclear Fusion in Condensed Matter," *Nature*, **338**, p. 365, (1989).
4. F. Paneth & K. Peters, "Über die Verwandlung von Wasserstoff in Helium," *Berichte d. Deutschen Chemischen Gesellschaft*, **B59**, 1926, (also **B60**, 1927) translated by P. Allison & K. Lockner, Los Alamos Nat. Lab., (1989).
5. As reported in: A. Fisher, "Much Ado About ... ," *Mosaic* a publication of the National Science Foundation), **21**, No. 2, pp. 12 - 23, (1990).
6. Id.
7. R. Beuhler, G. Friedlander, & L. Friedman, *Physical Review Letters*, Sept. 18, 1989, reported as: "Brookhaven Chemists Find New Fusion Method," *Science*, **245**, p. 1448, (1989).
8. Taken from: *Cold Fusion Research*, A report of the Energy Research Advisory Board to the U.S. Dept. of Energy, p.5, Nov. (1989).
9. c.f. *Science*, Vol. 256, p. 438, 24 April (1992).
10. Jackson, J.D., *Classical Electrodynamics*, 2nd Ed., Chapter 13, Wiley, N.Y. (1975)
11. Id. at p. 629, eqn. (13.44).
12. Id., p. 652, problem 13.2.
13. Id., p.652, prob. 13.1.
14. Id., p. 621, eqn. (13.11).

PROPRIETARY DATA  
For Evaluation Purposes Only

15. Id., p. 621, eqn. (13.9).
16. MathCAD Version 2.53, a product of Mathsoft, Inc., One Kendall Square, Cambridge, MA 02139.
17. Bohm, D., *Quantum Theory*, Prentice-Hall, N.Y., p. 513, (1951).
18. Bohm, op cit, p. 537, eqn. (35).
19. Jones, G.A., *The Properties of Nuclei*, 2nd Ed., Clarendon, Oxford, (1987).
20. Bohm, op. cit., p. 279
21. Stratton, J. A., *Electromagnetic Theory*, McGraw-Hill, N.Y., p.p. 162-163, (1941).
22. Bohm, op. cit., p. 521.
23. Id., p. 538.
24. Holden, N.E., *Handbook of Chemistry and Physics*, '91-'92 Ed., CRC Press, Boca Raton, Florida. 11-28 et seq.
25. c.f. Storms, E., op. cit., endnote 1 above.

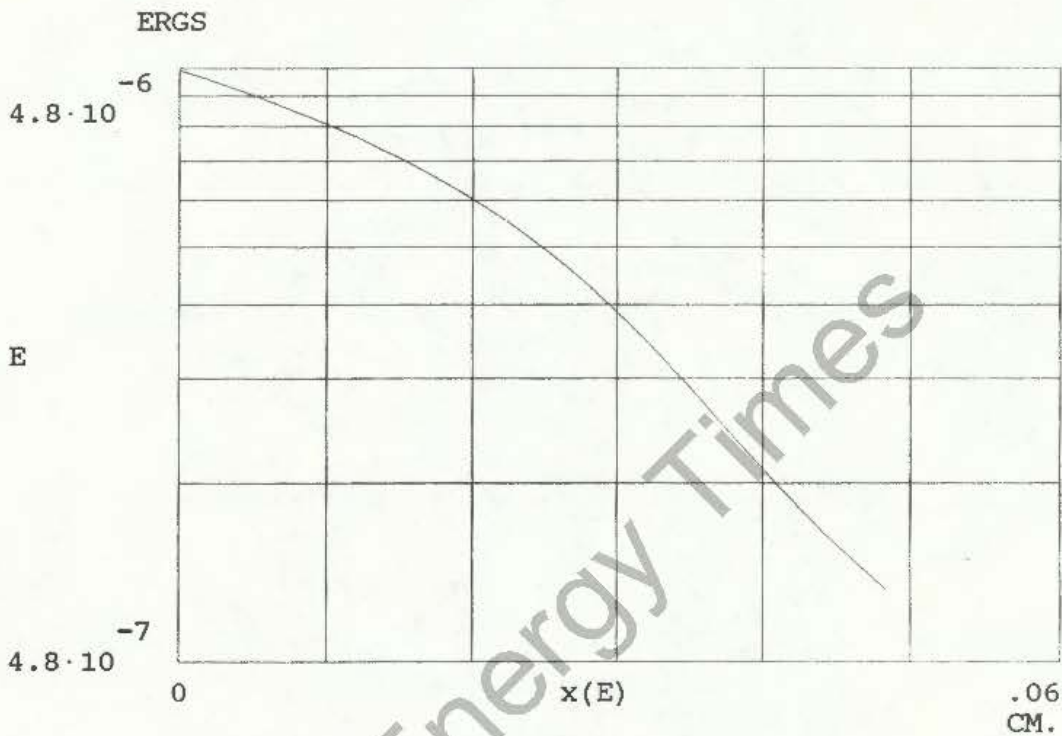

INCIDENT PARTICLE ENERGY VS. PATH LENGTH  
 (INITIAL ENERGY,  $E.t, = 3$  MEV.)



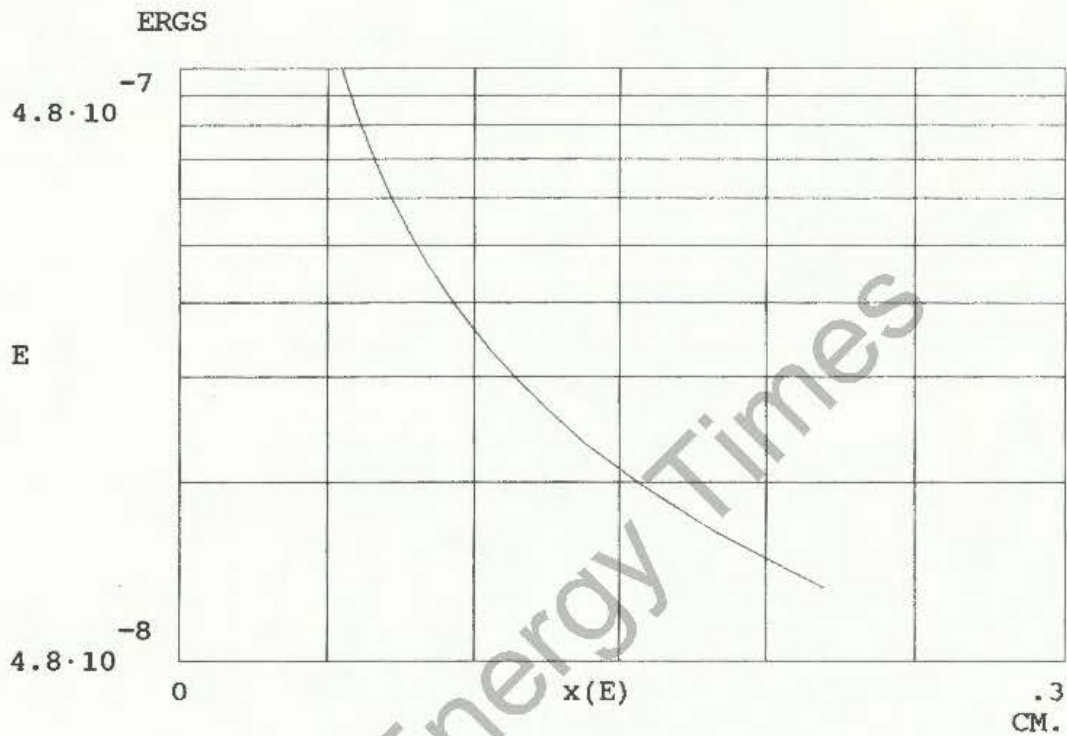

INCIDENT PARTICLE ENERGY VS. PATH LENGTH  
 (INITIAL ENERGY,  $E.t, = 3$  MEV.)

S  
C  
R  
E  
E  
N  
E  
D  
  
C  
R  
O  
S  
S  
S  
E  
C  
T  
I  
O  
N

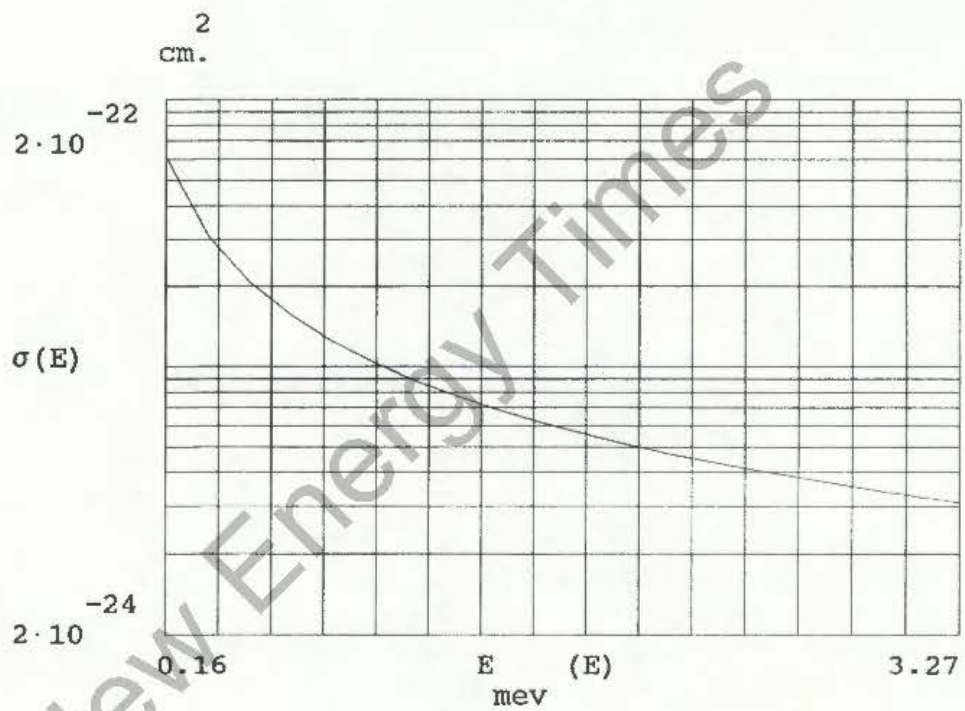

ATTENUATED BEAM ENERGY, (E.t = 3.27 mev)

E (E)  
mev

0.164
0.327
0.491
0.654
0.817
0.981
1.145
1.308
1.472
1.635
1.799
1.962
2.126
2.289
2.453
2.616
2.78
2.943
3.107
3.27

R(E)

0.052
0.018
0.011
0.009
0.007
0.006
0.005
0.005
0.004
0.004
0.003
0.003
0.002
0.002
0.002
0.002
0.001
0.001
0.001
0
0

CUMULATIVE

C  
O  
L  
L  
I  
S  
I  
O  
N  
P  
R  
O  
B  
A  
B  
I  
L  
I  
T  
Y

.02  
R(E)  
0

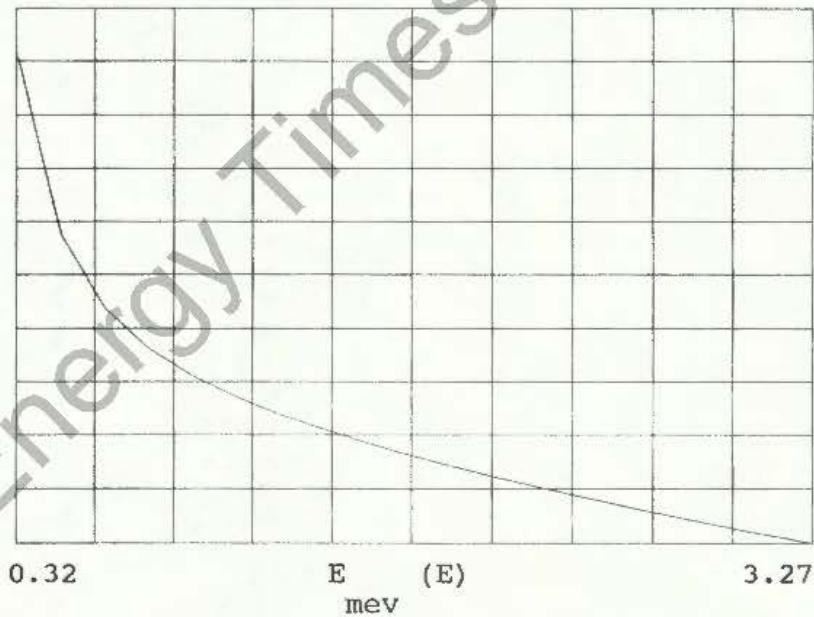

ATTENUATED BEAM ENERGY, (E.t = 3.27 mev)

E (E)  
mev

0.016
0.033
0.049
0.065
0.082
0.098
0.114
0.131
0.147
0.164
0.18
0.196
0.213
0.229
0.245
0.262
0.278
0.294
0.311
0.327

R(E)

0.982
0.648
0.374
0.23
0.152
0.106
0.077
0.057
0.043
0.033
0.026
0.02
0.015
0.012
0.009
0.006
0.004
0.003
0.001
0

CUMULATIVE

C  
O  
L  
L  
I  
S  
I  
O  
N  
P  
R  
O  
B  
A  
B  
I  
L  
I  
T  
Y

R(E)

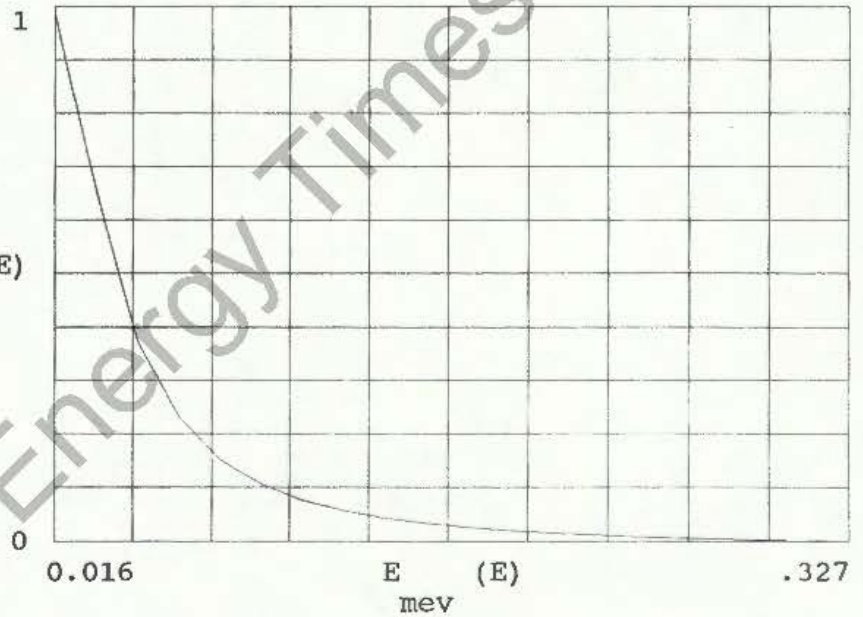

ATTENUATED BEAM ENERGY, (E.t = 0.327 mev)

T  
R  
A  
N  
S  
M  
I  
S  
S  
I  
O  
N  
  
P  
R  
O  
B  
A  
B  
I  
L  
I  
T  
Y

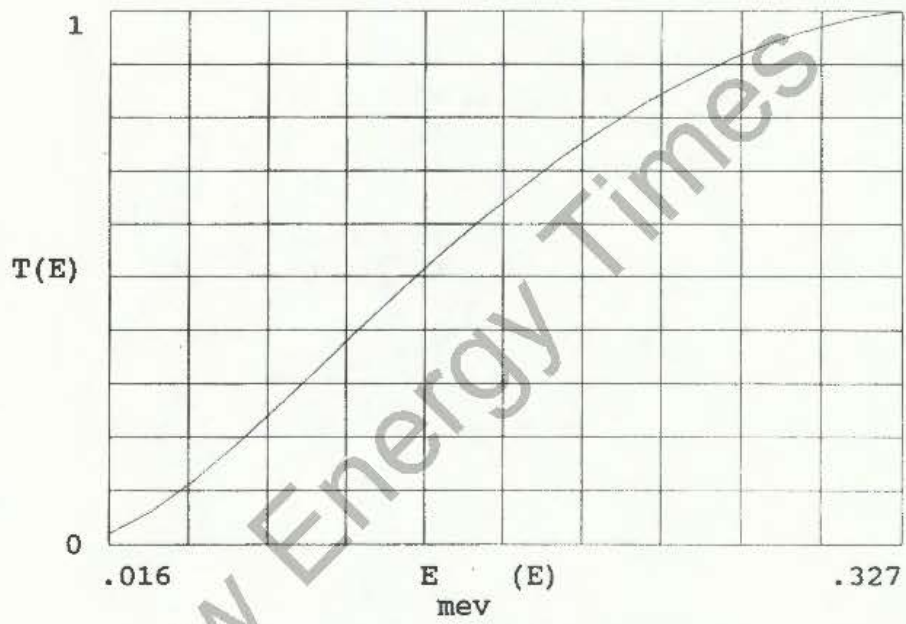

INCIDENT DEUTERON ENERGY, (MEV)

New Energy Times

N  
U  
M  
B  
E  
R  
  
P  
R  
O  
B  
A  
B  
I  
L  
I  
T  
Y

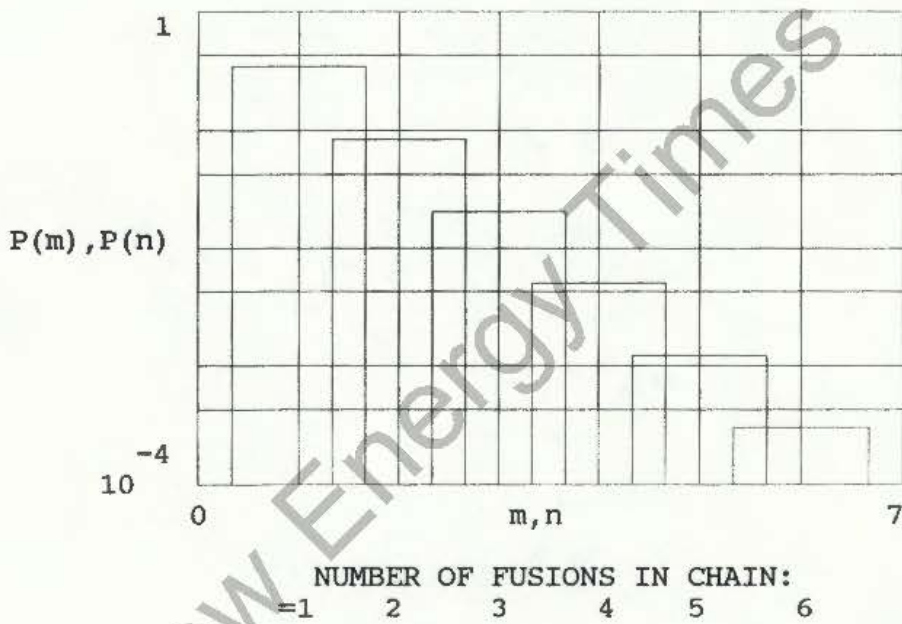

No response necessary

George Curtis Sponsler  
ATTORNEY AT LAW

7804 OLD CHESTER ROAD, BETHESDA, MARYLAND 20817  
TELEPHONE 301/320-3431

March 13, 1991

Dr. Edmond Storms  
Los Alamos Nat'l Laboratory  
Mailstop C-348  
Los Alamos, NM 87545

Dear Ed:

As we discussed by telephone earlier this week, at a recent meeting Walt Polansky suggested he might be receptive to a cost-sharing proposal from you and your colleagues there at Los Alamos to test my Cold Fusion "screening" theory experimentally. By "cost-sharing" Walt means that half the proposed expense would be covered by the Los Alamos Director's discretionary funds with the other half supported by DOE's Advanced Energy Projects Division. Walt told me he recently discussed such a possibility, if somewhat indirectly, by telephone with laboratory management at Los Alamos. Apparently there is possible funding for such a proposal, provided you prepared and supported it and that the proposal itself was well done.

I previously had written Secretary Watkins about supporting the experiment. He in turn referred my letter to Dr. Polansky who informs me that DOE, in accord with the ERAB Cold Fusion Report, is "sympathetic toward modest support for carefully focused and cooperative experiments within the present funding system." By "modest" I believe a \$330K proposal (\$280K for you and \$50K for me), with \$165 coming from DOE headquarters would fill the bill.

Walt Polansky also encouraged me to enquire of you if Los Alamos might fund my presentation of a seminar there on my new theory. Were you to do so we could better coordinate my input to your proposal, were you thereafter to decide to prepare one. Don't forget, George Chambers and his colleagues at NRL (who have also reviewed my theory affirmatively) stand ready to provide (under subcontract) encapsulated deuterium-impregnated palladium foils, should you so desire.

I was very encouraged by your report that experimenters elsewhere are acquiring evidence which appears to support my two-phase screening theory. Hopefully we can propose and conduct our own experiment which will both confirm the existence of the hypothesized "screening regions" and also the possibility of directly initiating phase two fusion, as I have proposed in my patent application.

Sincerely,



George C. Sponsler

cc: W. M. Polansky

FEB 06 1991

Mr. George C. Sponsler  
7804 Old Chester Road  
Bethesda, Maryland 20817

Dear Mr. Sponsler

Your letter of January 14, 1991, to Admiral Watkins, Secretary of Energy, regarding your cold fusion theory has been referred to me for reply. Although technical details were not provided, you did estimate that \$150,000 would be needed to perform an experiment to test this theory.

The Department of Energy remains receptive, at a modest scale and through its regular funding process, to high-quality research proposals aimed at understanding physical phenomena attributed to cold fusion. If your theory is based on sound, scientific principles and the proposed experiment would be within the above policy on cold fusion research, then you should submit a research proposal for evaluation.

However, let me add a note of caution. Our evaluation procedures for research proposals include a comprehensive, technical peer review. Before you proceed with the submission of a research proposal, I strongly urge you to discuss the scientific and technical features of the envisioned cold fusion experiment with a researcher from a local university who has successfully secured funding on the basis of peer reviewed proposals. An informal critique of your idea and its prospects for funding from such a source could be beneficial.

Please accept my best wishes in your future endeavors.

Sincerely,

Walter M. Polansky, Acting Director  
Division of Advanced Energy Projects  
Office of Basic Energy Sciences, ER-16

ER-16:WMPolansky:Denise:3-3054:C:\wpdata\sponsler.wp:2-4-91

File Congressional Escortra

bcc: ES/1, ER-622 ES#91-1054 ER#91-290 Due Date 2/1/91

ER-16

ER-11

ER-10

ER-61

WMPolansky

LIanniello

DStevens

DMayhew

2/4 /91

2/4 /91

2/4 /91

2/5 /91





U.S. Department of Energy

# Special Messenger Service

101330

Date and Time Requested 2/6/91 8:00AM

Organization ER-16

Number of Pieces 1

1. From: Sue Ellen Stottlemeyer

To: Francis Bryant, ER-622, 7A-140 Forrestal

2. From: S

To: \_\_\_\_\_

3. From: \_\_\_\_\_

To: \_\_\_\_\_

4. From: \_\_\_\_\_

To: \_\_\_\_\_

5. From: \_\_\_\_\_

To: \_\_\_\_\_

Contact at Delivery Point: Francis Bryant, 7A-140 6-5229

Name of Requestor and Phone #: Sue Ellen Stottlemeyer 3-5995

Messenger: \_\_\_\_\_

Remarks:

ES#91-1054

ER#91-290

Due Date: 2/1/91

NOTE: Classified Material MAY NOT Be Moved Thru This System.  
Return Completed Form to Dispatcher Upon Completion of Run.



Department of Energy  
Washington, DC 20585

FEB 6 1991

Mr. George C. Sponsler  
7804 Old Chester Road  
Bethesda, Maryland 20817

Dear Mr. Sponsler

Your letter of January 14, 1991, to Admiral Watkins, Secretary of Energy, regarding your cold fusion theory has been referred to me for reply. Although technical details were not provided, you did estimate that \$150,000 would be needed to perform an experiment to test this theory.

The Department of Energy remains receptive, at a modest scale and through its regular funding process, to high-quality research proposals aimed at understanding physical phenomena attributed to cold fusion. If your theory is based on sound, scientific principles and the proposed experiment would be within the above policy on cold fusion research, then you should submit a research proposal for evaluation.

However, let me add a note of caution. Our evaluation procedures for research proposals include a comprehensive, technical peer review. Before you proceed with the submission of a research proposal, I strongly urge you to discuss the scientific and technical features of the envisioned cold fusion experiment with a researcher from a local university who has successfully secured funding on the basis of peer reviewed proposals. An informal critique of your idea and its prospects for funding from such a source could be beneficial.

Please accept my best wishes in your future endeavors.

Sincerely,

*Walter M. Polansky*

Walter M. Polansky, Acting Director  
Division of Advanced Energy Projects  
Office of Basic Energy Sciences, ER-16

From: SPONSLER, GEORGE

Doc't date: 01/14/91 Doc't no: ER 9100209

Recvd date: 01/24/91 E.S. no: 91-0010254

Due date: 02/01/91 Rte sym: ER-16

Comp date: Other id: SPONSLER

Doc't type: LTR State code: MD

To: WATKINS

Subject: IS WORKING ON THEORY TO EXPLAIN COLD FUSION; HAS BEEN REVIEWED BY SCIENTISTS AT LOS ALAMOS AND NAVAL RESEARCH LAB

Conc. req: Classification: UNCL

Type action: REPLY DIRECT For sign of:

Encl/Remarks:

	Referred to	Ref date	For		Referred to	Ref date	For
1.	POLANSKY	01/24/91	ACTN	2.	ADLER	01/24/91	INFO
3.				4.			
5.				6.			
7.				8.			
9.				Last.			

Status:

Transaction completed -- 1 records processed.

Page 1

Count: \*0

DOB 5.27

U.S. DEPARTMENT OF ENERGY  
ACTION ITEMS MONITORING SYSTEM

New Energy Times

ACTIVITY: ~~ADD~~ SOURCE CODE: PM PUBLIC MAIL DO NOT DETACH FROM ORIGINAL CORRESPONDENCE

01/23/91 12:07

SPEC INT: 01/14/91 DATE CORR: 01/14/91 DATE RECD: 01/16/91 DATE CNTRL: 01/23/91 CONTROL NO: ES91-001054 DATE DUE: 02/06/91  
LETTER: MEMO: TWX: OTHER: TO: SECY: X DEP SEC: UN SEC: OTHER:

SPONSOR: SPONSOR, GEORGE C MD 0

REMARKS:

SUBJ: FINANCE & REVENUE FUNDING PROGRAMS IS WORKING ON THEORY TO EXPLAIN COLD FUSION; HAS BEEN REVIEWED BY SCIENTISTS AT LOS ALAMOS AND NAVAL RESEARCH LAB

FOR USE BY ACTION OFFICE ONLY

	ACTION REFERRED TO	DATE	RETURN TO	DUE DATE
1	Palomsky ER16			
2				
3				

ACTION TO: ER TYPE ACTION: Reply direct SIG OF:

CONCURRENCE INFORMATION: S DS US PE ES1 DD4  
FILE CODE: PMSPONSOR-ES91001054

CONTROL ANALYST: Gorham 6-5089

ALL DOCUMENTS FOR THE OFFICE OF THE SECRETARY MUST BE FORWARDED TO THE OFFICE OF THE EXECUTIVE SECRETARIAT FOR FINAL PROCESSING

New Energy Times

George C. Sponsler  
7804 Old Chester Road  
Bethesda, Maryland 20817

January 14, 1991

Hon. James D. Watkins  
Secretary, U.S. Department of  
Energy, 7A-257  
1000 Independence Avenue, S.W.  
Washington, D.C. 20585

Dear Mr. Secretary:

During the past year I have been working on a theory to explain cold fusion. My theory has been favorably reviewed by scientists at Los Alamos and the Naval Research Laboratory, and I have applied for a related patent. The theory hypothesizes the existence of a particular physical phenomenon which is subject to a definitive experiment.

Regrettably, because of budgetary limitations, I have been unable to secure funding to conduct that experiment. Dr. Walter Polansky, DOE's acting director of cold fusion projects, tells me that the needed money probably could be made available, if a guarantee could be made of a probable successful result. Of course such a guarantee is impossible, given the uncertain nature of all R&D experiments. But the hypothesis would appear to explain the ambiguities encountered by other experimenters.

The probable benefits would more than outweigh the risk of experimental failure. Could you make available from your discretionary funds the \$150,000 needed to permit the Naval Research Laboratory and me to undertake the needed experiment?

To introduce myself I would refer you to my biography in Who's Who. Should you wish a personal reference, I would suggest Senator Simon, whom I assisted several years ago as a Congressional Fellow.

Sincerely yours,



George C. Sponsler

cc: Senator Simon  
Dr. Polansky

01 JAN 19 11:33

file CF

ROUTING AND TRANSMITTAL SLIP

Date: 01/17/91

TO:	INITIALS	DATE
1. Don Stevens, ER-10		
2. Lou Ianniello, ER-11		
3.		
4.		
5.		

<input type="checkbox"/> Action	<input type="checkbox"/> File	<input type="checkbox"/> Note and Return
<input type="checkbox"/> Approval	<input type="checkbox"/> For Clearance	<input type="checkbox"/> Per Conversation
<input type="checkbox"/> As Requested	<input type="checkbox"/> For Correction	<input type="checkbox"/> Prepare Reply
<input type="checkbox"/> Circulate	<input checked="" type="checkbox"/> For Your Information	<input type="checkbox"/> See Me
<input type="checkbox"/> Comment	<input type="checkbox"/> Investigate	<input type="checkbox"/> Signature
<input type="checkbox"/> Coordination	<input type="checkbox"/> Justify	

REMARKS

RE: Attached letter from Mr. Sponsler

I told Mr. Sponsler funding for this research would be "difficult, but not impossible," and encouraged him to collaborate with LANL.

I also mentioned that, in the absence of reproducible experimental results that show "some effect, a theoretical investigation on this controversial subject may be viewed as a 'fishing expedition.'"

New Energy Times

FROM: <i>Walt</i>	Room No. - Bldg
Walt Polansky, ER-16	G-349
	Phone No.
	3-5995

George C. Sponsler  
7804 Old Chester Road  
Bethesda, Maryland 20817

January 14, 1991

Hon. James D. Watkins  
Secretary, U.S. Department of  
Energy, 7A-257  
1000 Independence Avenue, S.W.  
Washington, D.C. 20585

Dear Mr. Secretary:

During the past year I have been working on a theory to explain cold fusion. My theory has been favorably reviewed by scientists at Los Alamos and the Naval Research Laboratory, and I have applied for a related patent. The theory hypothesizes the existence of a particular physical phenomenon which is subject to a definitive experiment.

Regrettably, because of budgetary limitations, I have been unable to secure funding to conduct that experiment. Dr. Walter Polansky, DOE's acting director of cold fusion projects, tells me that the needed money probably could be made available, if a guarantee could be made of a probable successful result. Of course such a guarantee is impossible, given the uncertain nature of all R&D experiments. But the hypothesis would appear to explain the ambiguities encountered by other experimenters.

The probable benefits would more than outweigh the risk of experimental failure. Could you make available from your discretionary funds the \$150,000 needed to permit the Naval Research Laboratory and me to undertake the needed experiment?

To introduce myself I would refer you to my biography in Who's Who. Should you wish a personal reference, I would suggest Senator Simon, whom I assisted several years ago as a Congressional Fellow.

Sincerely yours,

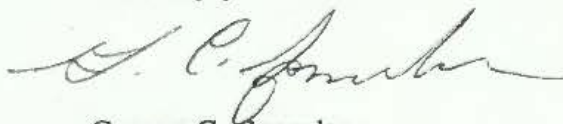

George C. Sponsler

cc: Senator Simon  
Dr. Polansky

*with copy of paper for your studies  
R. Polansky  
H. J.*

# DO NOT COPY

## COLD FUSION THEORY

by  
George C. Sponsler<sup>1</sup>

"I say not that it is, but that it seems to be, as it now seems to me to seem to be."

Hubert Alyea, former Professor of  
Chemistry, Princeton University

It is well known that the local electrostatic potential,  $V$ , of a perfect crystal lattice, to a first approximation (as seen by an absorbed deuterium atom), is spherically symmetric about the center of each palladium atom and roughly resembles a shielded Coulomb potential<sup>2</sup>:

$$V = \frac{Z_D Z_P e^2}{r} \exp(-r/r_0) \quad (1)$$

where  $Z_D$  ( $=1$ ) and  $Z_P$  ( $=46$ ) are the atomic numbers of deuterium and palladium, respectively;  $r$  is the radial distance from the center of a particular palladium atom;  $r_0$  the (radial) screening parameter; and  $e$  the electronic charge.

The total electrostatic potential resulting from all the atoms in the lattice is just the sum of the potentials caused by each ( $j$ th) atom:

$$V = \sum_j V(r-r_j) \quad (2)$$

In a perfect crystal  $V$  is periodic, in the sense that it is unchanged if  $r$  is displaced by any integral multiple of the basic lattice vectors.

In considering cold fusion I shall be more concerned with individual deuterium

---

<sup>1</sup> President, Law Mathematics and Technology Incorporated,  
7804 Old Chester Road, Bethesda, Maryland, USA, 20817.

<sup>2</sup> Bohm, D., Quantum Theory, Prentice-Hall, N.Y. (1951)  
pp. 240, 519.



atoms absorbed within a palladium matrix, rather than with the crystal lattice per se. More particularly, I shall focus upon the mutual scattering of diffused deuterium atoms within the palladium, each with a screened Coulomb potential given by the following:

$$V_d = \frac{e^2}{r} \exp(-r/r_o) \quad (3)$$

My basic hypothesis is that there are numerous small regions within the palladium where the crystal's electrons screen the nuclei Coulomb repulsion potential, in varying degrees, to a greater extent than would normally be expected in other metals. As will be shown later, this screening reduces the average scattering cross section, and correspondingly increases the mean free path of hydrogen and deuterium absorbed within the palladium, explaining the ease of diffusion therein which so characterizes their behavior.

I further hypothesize that in a very few places these screening regions are so intense that, effectively, they completely cancel the Coulomb repulsion barriers of any deuterium atoms which happen to be located therein. This hypothesized effective cancellation of the deuterium Coulomb barrier may actually be accomplished by one or both of two mechanisms: (1) an almost total reduction of the barrier accomplished, presumably, by a concentration of outer-orbit palladium screening electrons; or (2) by a partial such reduction accompanied by the existence or appearance of quantum resonances which enhance the probability of penetration of the remnant barrier.

Within these latter few regions, if the concentration of the absorbed deuterium is high enough, two deuterium atoms may meet by chance and fuse, thus explaining the uncertain cold fusion behavior observed experimentally.

The energy released by that fusion may then initiate a subsequent chain reaction of further fusions, provided the diffused deuterium density is again sufficiently great. I imagine this chain reaction as ceasing spontaneously after the deuterium density falls below a critical or threshold value. I thus envision the entire cold fusion process as occurring in two consecutive regimes: (I), an initial, perhaps prolonged, quiescent regime terminated by a chance or stochastic fusion event (which may also be triggered, as discussed later) within one of the screened regions; followed by, (II), a self-terminating chain reaction regime.

That the screening of the electrostatic Coulomb potential by the more intense hypothesized regions, (which permit the spontaneous fusion of two absorbed deuterium atoms that terminates the first regime, regardless of whether either or both of the two suggested mechanisms actually exists), must be practically total is easily demonstrated mathematically by considering the quantum tunneling through a rectangular potential barrier of height  $V_o$  and width  $a$ . The probability that an incident deuterium atom of energy  $E$  penetrates such a barrier, according to Rojansky<sup>3</sup>, is given

---

<sup>3</sup> Rojansky, V., Introductory Quantum Mechanics, Prentice-Hall, N.Y. 1950, p.216.

by:

$$T_E = \left[ 1 + \frac{V_0^2 \sinh^2 a \sqrt{(2m_d/\hbar^2)(V_0-E)}}{4E(V_0-E)} \right]^{-1} \quad (4)$$

in which the penetration probability is given by the transmission coefficient,  $T_E$ ;  $m_d$  is the mass of the deuterium atom; and  $\hbar$  is Planck's constant divided by  $2\pi$ .

If we evaluate eqn. 4 for representative values of the various parameters (e.g.  $V_0 = 4.5 \times 10^{-6}$  ergs,  $E = 6 \times 10^{-14}$  ergs, corresponding to  $15^\circ$  C or room temperature) and ask what is the transmission probability,  $T_E$ , for narrow potential barriers, we find that, if  $a = 10^{-16}$  cm, or only 1 fermi, the corresponding  $T_E = .002$ . In other words, the effect of the presumed shielding must almost be to remove completely the coulomb repulsion between the two fusing deuterium atoms! Figure 1, below, graphs the square-well transmission probability on a semi-log scale for a range of potential barrier widths,  $a$ , between  $10^{-16}$  and  $10^{-19}$  centimeters (where  $T.E.$  is  $T_E$  in MathCAD symbolism) at  $0^\circ$  C.

Once a single fusion event is initiated, if there is a sufficient density of deuterium within the palladium, some of the energy released may be transferred to other deuterium atoms nearby. Their resulting excited energy may permit them to fuse thereafter by quantum tunneling, even in the absence of screening. But such subsequent fusion might also, indeed may necessarily, be mediated by (and while within) the other less intense, but far more numerous, screening regions. If a sufficient amount of the energy released by a fusion event is transferred at each stage to yet other deuterium atoms, causing them to fuse in turn, the resulting chain reaction would be maintained as long as the deuterium density within the palladium were sufficiently high. When this "threshold" became greater than the residual deuterium density, the chain reaction would stop.

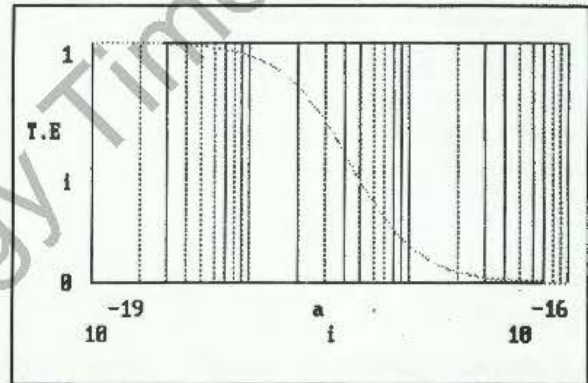

Figure 1: Transmission Probability

The chain reaction of regime II might also be effected by the type of fusion reaction actually encountered therein. I presume the initial fusion event, terminating regime I, must necessarily be a deuteron-deuteron reaction. But the by-products of that reaction may include a proton or a neutron which in turn, by some unknown reaction, might then further react with other absorbed deuterium atoms to produce the needed chain reaction. But the thermal chain seems more likely, with the reaction by-products, whatever they may be, serving to transmit the binding energy released by the fusion to the subsequent reactions.

What might these hypothesized screening regions actually be? Classically, were it possible for  $n$  electrons to be held closely together with a single proton, the resulting

net (negative) electrostatic field would be that of  $(n-1)$  electrons; the (positive) proton field would be screened out by the electrons. Quantum mechanically, the situation is far more complex. But I hypothesize that some such phenomenon is just what takes place within the palladium, permitting the cold fusion of two deuterium atoms which by chance find themselves in close proximity to each other within such a screening region. Indeed, an imbalanced electron cloud concentration might even result in such a screened region actually attracting to itself a second thermal deuteron nucleus, thereby enhancing the probability of its fusion (by quantum tunneling) with a first deuteron nucleus already contained therein.

There are various possible physical explanations for these hypothesized regions. They might simply be heretofore unrecognized characteristics of the palladium crystal.

A recent issue of Science<sup>4</sup> tells of "Clusters", small groups of atoms which display unusual solid state properties. "In bulk materials, electrons can move freely in any direction, but in clusters they are confined to a space that is only a few atom widths across."<sup>5</sup> Clusters, or some similar palladium crystal imperfection, may explain the screening of deuterium by palladium. Palladium does demonstrate cluster behavior (indeed, a photo in the same article shows "Patchwork Palladium, an electron micrograph reveals tiny grains in cluster-assembled").<sup>6</sup> Such clusters might be spread throughout the palladium lattice, each containing one or more regions in which the constrained palladium electron "cloud" screens the Coulomb charge of any deuterium atom which finds itself in such regions. The "constraint" effected by the cluster might concentrate the electrons in the vicinity of the deuterium nucleus, thereby effecting cancellation, which is not observed at such close quarters in "normal" nuclear screening where the electron orbits are far removed from the screened nucleus which holds them in orbit. Of course, these clusters may not be responsible for the hypothesized regions which might also result from unknown properties of, or impurities within, the palladium crystal.

#### Cold Fusion Probability:

##### Regime I

During a brief interval of time,  $\delta t$ , the (differential) probability,  $P_r$ , of a single cold fusion event within a particular screened region is equal to the probability that two deuterium atoms collide within a screened region (that is, at a point where the deuterium Coulomb barrier potential is effectively negated by the palladium electrons) as given by equation 5, in which  $\rho_d$  is the deuterium particle density (number of atoms per cc) within the palladium;  $\sigma$  is the mutual scattering cross section of the deuterium atoms within the palladium (where the subscript,  $r_0 \rightarrow 0$  means the value thereof as the

---

<sup>4</sup> "Clusters: Strange Morsels of Matter", Science, Vol. 248, 8 June 1990, p. 1186.

<sup>5</sup> Id.

<sup>6</sup> Id at 1187.

$$P_f = \rho_d \sigma_{r_o=0} \delta x$$

Where

$$\sigma_{r_o=0} = \frac{16\pi m_d^2 e^4 r_o^4}{\hbar^4} \quad (5)$$

screening radius,  $r_o$ , approaches zero, i.e. complete screening)<sup>7</sup>;  $m_d$  is the mass of a single deuterium atom;  $e$  is the electron charge in esu;  $\hbar$  is Planck's constant divided by  $2\pi$ ; and  $\delta x$  is the average length of an arbitrary deuterium atom trajectory intercepted by the region wherein the screened potential is effectively zero.

As we do not know the shape of the region we cannot calculate  $\delta x$  (as we could, for example, were the screened region spherical and if we also knew the value of  $r_o$ ). But we can estimate that  $\delta x$  probably is less than the diameter of a palladium atom ( $\sim 10^{-8}$  cm) but greater than the diameter of a palladium nucleus ( $\sim 10^{-12}$  cm), with the smaller value being more likely.

The probability,  $P_p$ , that one or more spontaneous cold fusion events occur within a total volume of palladium,  $V_p$ , is given by:

$$P_p = 1 - [1 - P_f]^{\rho_s V_p} \quad (6)$$

where  $\rho_s$  is the screened-region density (number of regions per cc) within the palladium.

To approximate the time-dependence of the probabilities,  $P_f$  and  $P_p$ , I assume the particle density (or concentration) of the deuterium absorbed within the palladium rises exponentially from an initial zero value, approaching the deuterium concentration,  $\rho_{de}$ , in the surrounding electrolyte asymptotically, in accord with:

$$\rho_d = \rho_{de} [1 - e^{-t/t_d}] \quad (7)$$

where  $t_d$  is the relaxation time-constant characteristic of the build-up of absorbed deuterium within the palladium.

It is important to realize that neither  $P_p$  nor  $P_f$  are cumulative probabilities; rather, they are both differential probabilities of collision (and hence of fusion in a completely screened region) of two deuterium atoms within some brief interval of time, say  $\delta t$ . Their apparent time dependence merely reflects the assumed growth of concentration of the absorbed deuterium within the palladium.

Nevertheless, formulae 5 & 6 are still highly instructive. Figure 2 illustrates the time dependence of  $n_d$ ,  $P_f$ , and  $P_p$  (where, once again, MathCAD has introduced the dummy array subscript  $\hat{i}$ ) for certain assumed values of the associated parameters (namely:  $r = 10^{-10}$  cm;  $\rho_s = 10^{21}$  per cc;  $\delta x = 10^{-10}$  cm;  $V_p = 10^3$  cc; and  $\rho_s = 10$  per cc):

<sup>7</sup> Taken from Bohm, op cit, eqn. 35, p.537, (multiplied by an additional  $4\pi$  steradians, representing integration over the full solid-angle sphere).

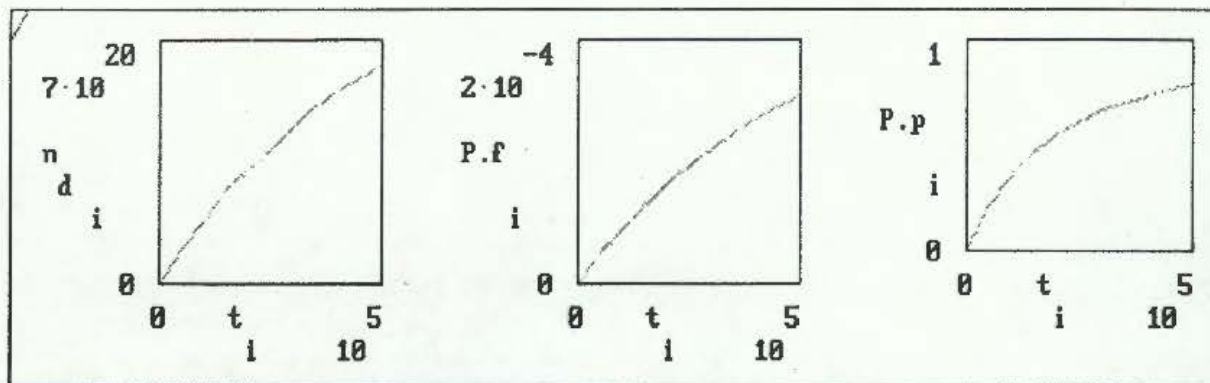

Figure 2: Illustrative Time Dependence for Assumed Parameters

The third graph shows that the overall probability,  $p_p$ , that at least one fusion will occur somewhere in the volume,  $V_p$ , approaches unity slowly and asymptotically, with a 50/50 chance about eleven hours after initiation of electrolysis (for the assumed parameters). Such behavior is typical of experimental results. It implies that the actual concentration of "total" screening regions is small, comparable to the assumed value (i.e., a few per cc), but that a cold fusion event eventually will occur, if the experimenters are patient (again characteristic of actual experiments), and if one of the relatively scarce "total" screening-regions happens to be present in the volume.

Indeed, the equations are very sensitive to the values of all the parameters, the examples given here are only illustrative.

I have noted previously that the hypothesized palladium screening regions may also account for (or at least contribute to) the experimentally observed ease with which hydrogen (and deuterium) diffuses through palladium. The explanation is simply that the overall effect of all the screening regions is to increase the average mean free path of the hydrogen absorbed within the palladium. (The seeming tautology arises because the mean free path of the hydrogen within the palladium differs at points within and without of the screening regions, which are also, presumably, of differing strengths).

In terms of the hydrogen (or deuterium) particle density,  $\rho$ , and of the (angular) scattering cross section,  $\sigma_a$ , the mean free path,  $l$ , is given by:

$$l = \frac{1}{\rho \sigma_a} \quad (8)$$

where, according to Bohm<sup>8</sup>:

<sup>8</sup> Bohm, op cit, p. 537, eqn. (35).

$$\sigma_{\Omega} = \frac{4m^2 (Z_H Z_p)^2 e^4}{(4p^2 \sin^2 \Omega / 2 + \hbar^2 / r_o^2)^2} \quad (9)$$

in which  $m$  is the mass of the hydrogen (or deuterium) atom,  $Z_H$  is the atomic number of the hydrogen (or deuterium) atom,  $Z_p$  is the atomic number of palladium,  $e$  is the electronic charge in esu,  $\Omega$  is the scattering angle,  $\hbar$  is Planck's constant divided by  $2\pi$ , and  $p = (2mE_o)^{1/2}$  is the hydrogen (or deuterium) momentum in terms of its energy,  $E_o$ , and  $r_o$  is the effective radius of a screening region.

From (9) we observe that the angular scattering cross section increases with the squares of both the mass and the atomic number of the diffusing particle, which explains why only hydrogen and deuterium diffuse with such relative ease through - and, by this same mathematical model, are capable of fusing within - palladium. We also note (as previously discussed with regard to equation 5, above) that as  $r_o \rightarrow 0$  the cross section rapidly approaches zero, with a correspondingly increasing mean free path, showing that the effect of the screening regions is to facilitate the diffusion of hydrogen (or deuterium) through the palladium.

#### Regime II

The second regime is introduced by a spontaneous fusion event within some (effectively total) screening region, marking the end of the preceding regime I. A chain reaction of succeeding fusions will follow, if sufficient energy is transferred between successive fusions to maintain a continuing reaction, (or if some other as yet unidentified nuclear reaction produces a chain reaction via its fusion by-products). That is to say, to sustain the regime II chain reaction sufficient energy must be transferred at each successive stage to permit the deuterium atoms of the succeeding fusion event(s) to penetrate their mutual Coulomb electrostatic repulsion barriers. By now partially screening the barrier potential between pairs of deuterium atoms fortuitously located within them, the hypothesized screening regions, may reduce the repulsion potential sufficiently to permit mutual penetration and fusion by the excited deuterium.

For this reason, it is more likely that a chain reaction could be initiated among deuterium atoms absorbed within palladium more easily (or perhaps at all) than would be possible, say, in a deuterium gas.

The screening regions are thus seen to facilitate both the initial spontaneous fusion ending regime I (via a comparatively rare total screening region) as well as the chain reactions of regime II (via the more common partial screening regions).

The binding energy which is released by each fusion event is the source of the subsequent energy needed to continue the chain reaction. It's magnitude depends upon the particular nuclear reaction involved. But even with quantum mechanical tunneling, a substantial fraction of the peak Coulomb repulsion potential (typically on the order of  $45 \times 10^{-6}$  ergs or about 28 mev, since  $1 \text{ mev} = 1.59 \times 10^{-6} \text{ erg}$ ) would be required to maintain the chain reaction during regime II. (For comparison, such tunneling permits alpha particle emission from Uranium with energies on the order of  $6.6 \times 10^{-6}$  ergs). The excess energy released would appear as heat and could be extracted for electrical power generation.

Born<sup>9</sup> gives a table of artificial nuclear transformations which shows that, conventionally, when deuterium bombards deuterium, the products are either tritium, T, and a proton, H, or  ${}^3\text{He}$  and a neutron, n. Cold fusion experimenters claim to have found both neutrons and tritium, which indicates these are the actual reactions involved.<sup>10</sup>

About 4 mev would be released by either of the two permitted fusion reactions. As with the alpha particle emission comparison, 4 mev might be enough to permit quantum tunneling, and subsequent fusion, of pairs of deuterium atoms even outside a screening region (with, as noted above, presumably a greater probability within a screening region). The resulting fusion would release another 4 mev (with a total 8 mev thereafter available) which would permit continuation, and spreading, of the chain reaction until the deuterium concentration fell below the hypothesized required threshold level.

Although it has not been observed, I suggest that at thermal energies  $\text{He}^4$  might also be produced by the initial (regime I) fusion event. Because the energy of the parents of a fusion must be greater (by the binding energy) than the sum of the daughters' energy<sup>11</sup>, it follows that two deuterium atoms at near thermal energy theoretically could fuse into a single helium atom (but the latter without externally supplied excitation energy could not decay spontaneously into two deuterium daughters). About 22.3 mev would be released by this hypothetical reaction, an amount which would substantially increase the probability of initiating or sustaining a subsequent chain reaction, especially if intervening collisions were to dissipate some of the energy before a succeeding fusion event.

The critical parameter for continuation of the chain reaction is the density or concentration of the screening regions within the palladium: if the regions are too widely separated, the fusion energy will dissipate (through collisions with the palladium lattice) to the point where insufficient energy remains to initiate fusion anywhere (except by chance thermal collision within some total screening region, i.e. a return to regime I).

I model this second regime mathematically (if inaccurately, since I employ classical rather than quantum mechanics) as follows.

The classical equation for diffusion (read conduction) of heat in a homogenous, isotropic solid is given by<sup>12</sup>:

where  $\nabla^2$  is the Laplacian operator,  $\rho$  is the density of the solid,  $c$  its specific heat, and  $K$  its thermal conductivity. In our application, the "solid" is the palladium crystal.

---

<sup>9</sup> Born, M., Atomic Physics, 4th Ed, Hafner Pub. Co., N.Y. 1946, p. 69.

<sup>10</sup> According to Born, hydrogen and deuterium do not interact.

<sup>11</sup> c.f. Scientific American, March, 1990, p.59.

<sup>12</sup> Carslaw, H. S. and Jaeger, J. C., (1950), Conduction of Heat in Solids, Oxford, Clarendon Press, chapter 1, \$6.

$$\rho c \frac{\partial v}{\partial t} = K \nabla^2 v \quad (10)$$

I assume regime I is terminated by a single spontaneous stochastic fusion reaction between two arbitrary deuterium atoms, resulting in the release of the corresponding binding energy,  $B$ , at a single point within the palladium lattice. I postulate  $(3/2)k v_0 = B$ ,  $v_0$  being the initial temperature at the point where the fusion occurs and  $k$  being Boltzman's constant. I further assume local spherical symmetry, in which case the Laplacian is a function only of the radius,  $r$ , drawn from the initial point of fusion. The heat conduction equation then becomes:

$$\frac{dv}{dt} = \kappa \left[ \frac{d^2 v}{dr^2} + \frac{2}{r} \frac{dv}{dr} \right] \quad (11)$$

where  $\kappa = K/\rho c$ .

As Lord Kelvin first proposed, the solution of eqn. 11 for such an instantaneous point source is given by<sup>13</sup>:

$$v = \frac{B}{8 \rho c (\pi \kappa t)^{3/2}} e^{-r^2/4\kappa t} \quad (12)$$

This equation satisfies the requirements for a Dirac  $\delta$  function, as it should for an instantaneous point source.

Using equation (12), figure 3 illustrates how the average temperature builds to a peak (after  $6 \times 10^{-17}$  seconds), and then drops off to a near zero value (after about  $10^{-16}$  sec) at a point  $10^{-9}$  cm from the initial fusion event.

Neglecting the unlikely possibility of transformation products of the initial fusion event initiating subsequent fusions (e.g., by  $\gamma$ ,  ${}_0n^1$ ,  ${}_1H^1$ , or  ${}_2He^3$  somehow reacting with  ${}_2D^2$ ), whether or not a chain reaction of subsequent fusions will follow this initial, spontaneous event will be determined by: the concentration of the deuterium diffused within the palladium; the transfer of the released binding energy to nearby deuterium atoms in sufficient amount to permit fusion outside a screening region by quantum tunneling; or by transferring sufficient energy to another pair of deuterium atoms fortuitously located within a nearby screening region; or by

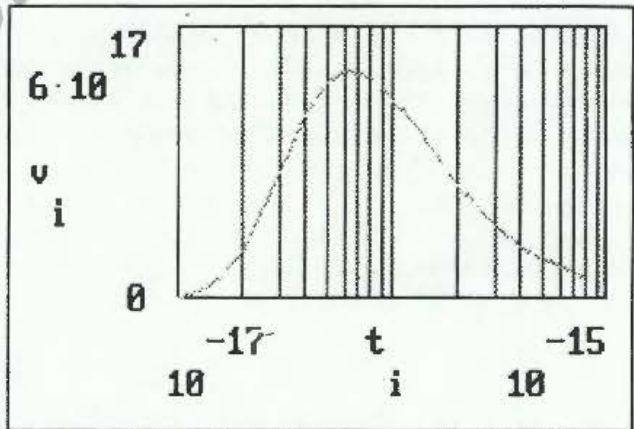

Figure 3: Temperature vs. Time

<sup>13</sup> Id, at 218.



the chance diffusion of another pair of deuterium atoms into the very region in which the initial fusion event occurred.

Such energy transfer could be effected by collision of a fusion by-product with another deuterium atom, or perhaps even by a phonon transmitted to the subsequent deuterium atom through the palladium lattice. But the classic heat conduction equation makes no such distinction, contenting itself with calculation of average temperatures.

To the extent the classical heat conduction equation is applicable, insufficient heat would seem to diffuse to just the next atom (much less screening region) to permit a chain reaction. But the binding energy released at fusion actually appears in the form of the kinetic energy of the by-products, not as a classical heat wave. Those particles, in turn, must travel at least as far as the nearest palladium lattice atom ( $\sim 10^{-8}$  cm); hence, the average path must be somewhat greater, and a chain reaction should be possible on the quantum scale, if the deuterium concentration is sufficiently great.

The regime I release of the (comparatively enormous amount of) fusion energy might destroy the initial screening region itself. If other screening regions were required to maintain the resulting chain reaction, the released binding energy would have to be transmitted to other deuterium atoms in an adjacent region. But if quantum tunneling were the chain reaction mechanism, then the energy would only need to be transmitted to nearby deuterium atoms not necessarily located within a screening region. Thus, particularly as the density of deuterium is presumably greater than the density of regions, this fact would seem to argue in favor of quantum tunneling, without the need of other screening regions, as the mechanism by which the presumed chain reaction is maintained.

Proposed experiment:

But all such speculation is premature until it is known whether or not the hypothesized screening regions actually exist. I propose to search for them experimentally, using a molecular beam to make a sophisticated measurement of the angular scattering cross section given by equation 9 above.

As  $r_0$  in (9) approaches infinity (i.e., when there is no shielding) the cross section becomes that of the (classical) Rutherford scattering law:

$$\sigma_0 = \frac{(Z_R Z_P e^2)^2}{16 E^2 \sin^4 \frac{\Omega}{2}} \quad (13)$$

As Bohm<sup>14</sup> points out, the complete agreement between the two for all angles of scattering is a special property of the Coulomb law of force; the classical and quantum results disagree for an arbitrary force law. To demonstrate the existence of the hypothesized screening regions, we need only study the deviations of the experimental cross section from the Rutherford law.

In general appearance, as shown by figure 4 (which assumes  $r_0 = 10^{-10}$  cm and

---

<sup>14</sup> op cit, p. 538

$E = 3\text{mev}$ ), the cross section for a shielded Coulomb force, as a function of the scattering angle,  $\Omega$ , and as is characteristic of the classical Rutherford cross section, rises steeply with decreasing  $\Omega$  until the two terms of the denominator in equation (9) become approximately equal at some particular value,  $\Omega_0$  (in fig. 4 at about  $5 \times 10^{-4}$  radians, or about 0.03 degrees). For yet smaller angles the increase in magnitude of the scattering cross section is comparatively small<sup>15</sup>. Thus  $\Omega_0$  may be regarded as a sort of minimum angle, below which Rutherford scattering ceases, as a result of shielding, and shielding becomes predominant. The particular value of  $\Omega_0$  depends upon both the relative momentum of the scattering particles and upon the effective shielding radius,  $r_0$ , in accord with the following expression:

$$\Omega_0 = 2 \sin^{-1} (\hbar / 2pr_0) \quad (14)$$

We can use (14) to gain an idea as to the magnitude of  $r_0$  at which shielding becomes effective, namely, by evaluating (14) for several values of  $r_0$ , to see with what  $\Omega_0$  they correspond. Thus choosing  $r_0$  to be  $10^{-7}$ ,  $10^{-8}$ , and  $10^{-9}$  cm, we see the corresponding  $\Omega_0$  are 0.017, 0.172, and 2.057 radians, respectively, for thermal energies near  $0^\circ\text{C}$ .

To this point I have implicitly assumed that the screening regions were each centered upon some palladium atom. This assumption may not be valid; the regions might result from interaction of the absorbed deuterium atoms with the palladium electron cloud in some as yet unknown manner. Indeed, intuitively, it would appear far more likely that the hypothesized screening regions would result from local concentrations of the palladium crystal lattice electron cloud, relatively far removed from the palladium nuclei.

It would be most difficult with only a personal computer to calculate the interaction of two deuterium atoms with the palladium electron cloud. This cloud is actually the density distribution of the electrons, which is obtained by multiplying the wave function,  $|\psi|^2$ , for a definite quantum state by the charge,  $e$ , of the electron.<sup>16</sup> A super computer might even be required to define the wave function in the related multidimensional phase space. However, the hypothesized screening regions should

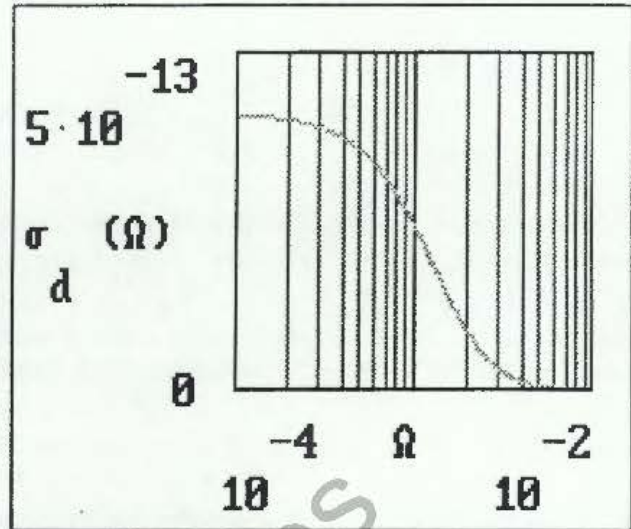

Figure 4: Deuterium Cross Section per unit solid angle.

<sup>15</sup> Bohm, op cit, p. 538

<sup>16</sup> Born, op cit, at 141.

be amenable to experimental verification by probing the palladium crystal with an opposing pair of hydrogen or deuterium molecular beams.

Experimental procedure:

I propose to test the foregoing cold fusion theory by searching for the hypothesized screening regions on which the theory is based. If the regions exist, the theory is substantiated; if not, not. The experiment would be definitive.

The experimental approach I propose is to study the scattering of, first one and thereafter two opposing, monoenergetic beam(s) of hydrogen or deuterium. I would use single beams first to locate, and then to study scattering from, screening regions centered on palladium crystal nuclei. To determine the existence of other regions not so associated (e.g. created by or located within concentrated electron clouds), two colliding beams would be employed. I would measure the angular scattering cross section of the hypothesized regions for a variety of beam energies, foil thicknesses (typically  $5 \times 10^{-6}$  cm), impact locations, and palladium crystal compositions. (By compositions I mean to imply a study of palladium foils fabricated by different procedures and manufacturers, giving emphasis to those with high cluster concentration and to batches from which palladium rods have been drawn which are believed by others to have exhibited cold fusion). Skilled experimenters and sophisticated apparatus would be demanded (such as may be available at the California Institute of Technology).

The use of hydrogen beams alone should be adequate to substantiate the existence, vel non, of the hypothesized screening regions. But the additional use of a pair of colliding deuterium beams would better test the hypothesis, and might even lead to a rare cold fusion event when the pair collided within a correspondingly rare, "total" screening region. The pair of deuterium beams could also be used to test the triggering of the regime II chain reaction.

The proposed experiment is complicated by the fact that neither the density nor the size of the hypothesized screening regions is known. But the latter is probably small: on the order of atomic dimensions, say something in the range  $10^{-12}$  to  $10^{-9}$  cm. And the number of total screening regions is probably quite small. These facts in turn demand that the incident molecular beam(s) be well defined, that is, of narrow geometrical cross section, and that a large number of palladium foils be tested. High accuracy would be required of the angular measurement of the scattering cross section as the incident beam(s) scanned across the palladium foil target.

Crystallographic studies should also be undertaken to assure that the crystal structure of the palladium foils duplicates that of the palladium rods, especially those which purportedly have demonstrated cold fusion in work by others.

Power reactor applications:

If the proposed experiment demonstrates the existence of the hypothesized screening regions, application of this cold fusion theory to the design of a practical electric power reactor is obvious. The key is to trigger the initial fusion event which terminates regime I. Two methods present themselves: (1) metallurgy, by increasing the number of "total" screening regions within the palladium; and (2) artificial ignition, by bombarding the deuterium absorbed within the palladium with high-energy

deuterium atoms from outside the palladium. This latter appears more promising.

Various engineering approaches to artificial ignition present themselves. For example, the palladium - immersed in a saturated deuterium electrolyte - might be fabricated into long, hollow rods centered on electrically-charged wires which, energized by a high-voltage pulse, would accelerate the deuterium ions between the central wire and surrounding palladium, causing them to bombard the palladium cylinder. These bombarding ions would have a higher probability of penetrating the Coulomb potential barriers of the absorbed deuterium atoms located in the "partial" (and far more numerous) screening regions, there initiating the fusion chain reaction of regime II, bypassing regime I altogether. If the electrolytes within and without of the palladium cylinders were separate - with the internal being charged by deuterium which diffused through the palladium from that outside - the deuterium concentration in the electrolyte separating the central wire from the surrounding cylinder could be sensed electronically, and the voltage pulse automatically applied when the concentration had reached a sufficient, predetermined level.

Once regime II has been triggered, the engineering problems differ. Now we must prevent melting, while utilizing the heat generated for electric power, and maintain or replace the concentration of the absorbed deuterium. The latter problem would seem easily solved by using multiple palladium (say) rods independently controlled and immersed in a common electrolytic bath.

Other alternatives, derived from the theory, are possible. The foregoing have been offered only to illustrate the possibilities. The key to all is the proposed experiment to determine the existence of the hypothesized screening regions. If they are found, the rest will follow.

**DO NOT  
COPY**